

MAD E L

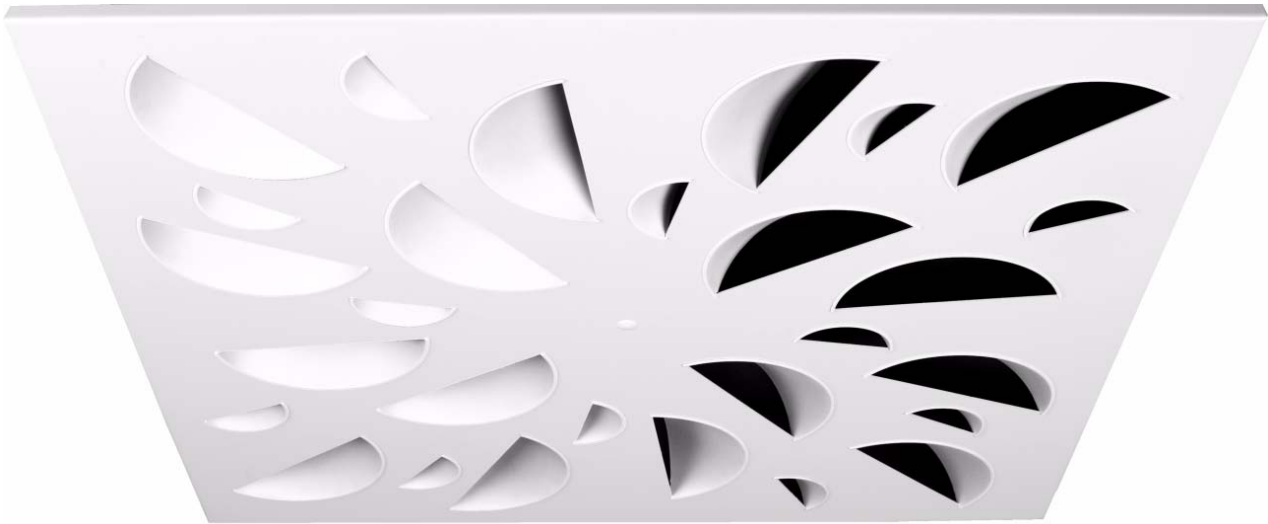

Diffuser NEX : Design Lievore, Altherr & Molina



Patented

NEX concave elements swirl diffusers

MAD E L

The **NEX** swirl diffusers are designed to be applied in air conditioning ventilation and heating systems. They can be mounted in false ceilings or suspended from ceiling.

The design of their concave elements and its radial arrangement in the diffuser cause a swirl air supply with a coanda effect, which provides a high level of induction rate of the air in the atmosphere and reducing the stratification. Concave elements emit a uniform air flow all over the passage section.

The **NEX** series diffusers are designed for both CAV and VAV installations. These diffusers can be used from 2,6 up to 4 meters high and at a temperature differential up to 12°C.

Models:

NEX-S

NEX-S-KLIN

NEX-C

NEX-S

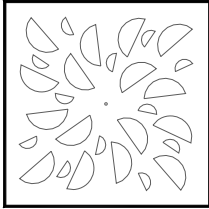

NEX-S.../SR/

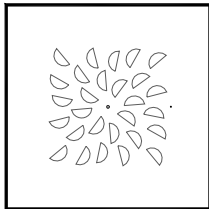

NEX-S.../T.../

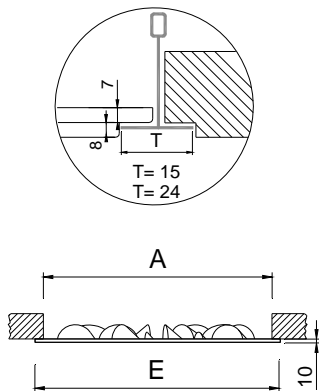

	E	A
400	395	376
500	495	476
600	595	576
610	605	591
625	620	601
675	670	651

NEX-S

Classification

NEX-S Square diffuser with black ABS diffusion elements.

.../SR/ Reduced face area in relation to the diffuser size.

.../T15/ Panel with angled borders to replace an angled ceiling tile profile 15 mm.

.../T24/ Panel with angled borders to replace an angled ceiling tile profile 24 mm.

Material

Diffuser constructed from galvanised steel and diffusion elements in ABS plastic.

All diffusers are provided with a seal on the back of the frame in order that the perimeter in contact with the plenum box or the ceiling is airtight.

BOXSTAR

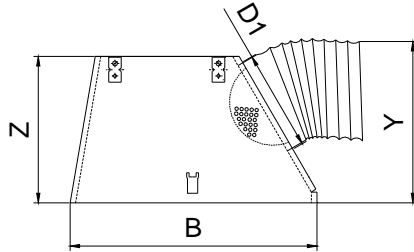

BOXSTAR /S/

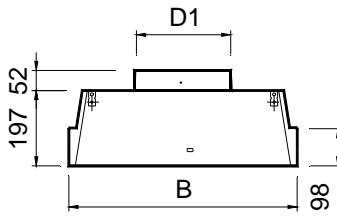

	B	Z	Y	D1
400	390	300	325	198
500	490	300	325	198
600-D1:250	590	350	375	248
600-D1:200	590	300	325	198
610-D1:250	600	350	375	248
610-D1:200	600	300	325	198
625-D1:250	615	350	375	248
625-D1:200	615	300	325	198
675-D1:250	665	350	375	248
675-D1:200	665	300	325	198

BOXTHERM

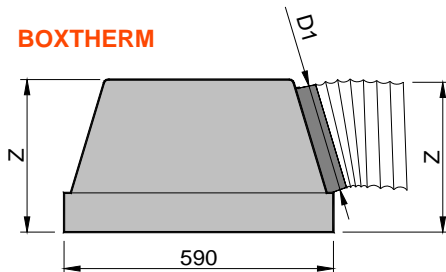

	Z	D1
BOXTHERM 600-DIAM250	350	248
BOXTHERM 600-DIAM200	300	198

Accessories

BOXSTAR Plenum box with a lateral circular connection. It includes supports to hang from the ceiling. The crossbar is supplied separately to be assembled manually on the work site. Made in galvanised steel.

...-R Plenum box with a flow damper in the spigot.

.../S/ Plenum box with an upper connection.

.../AIS/ Thermally insulated plenum box with foam. Density 30 kg / m³ ISO 845. Thermal conductivity 20° C_0,040 W / m°K ISO 3386/1.

Classified reaction to fire B-s2, d0 EN 13501-1.

BOXTHERM Plenum box thermo acoustically insulated with a lateral circular connection.

...-R Plenum box with a flow damper in the spigot.

PMXO Crossbar suitable for mounting in false ceiling with rectangular duct.

1)

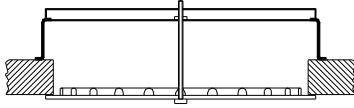

Fixing systems

1) Connection into the crossbar or to the plenum box by means of central screw.

1)

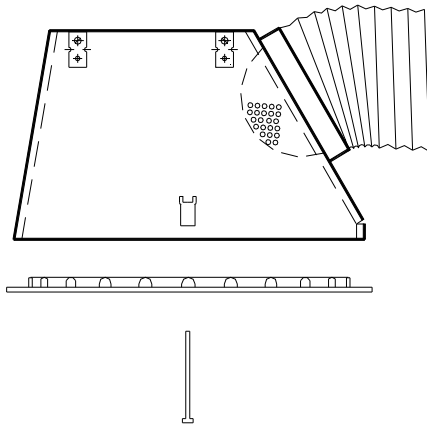

Finishes

- M9016** Painted in white similar to RAL 9016.
- R9010** Painted in white RAL 9010.
- RAL...** Painted in other RAL colours.
- .../EB/** ABS plastic elements in white.
- .../EL/** ABS plastic elements in lavender blue.
- .../EV/** ABS plastic elements in pistachio green.
- .../ER/** ABS plastic elements in red.

Specification text

Supply and mounting of square swirl diffuser with fixed concave elements in radial disposition series **NEX-S+BOXSTAR-R M9016 dim. 600** constructed from galvanised steel paint in white **M9016** and diffusion elements in black ABS. With lateral circular connection pyramidal plenum box and air flow damper in the spigot **BOXSTAR-R**. Manufacturer **MADEL**.

NEX-S-KLIN

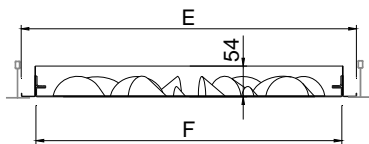
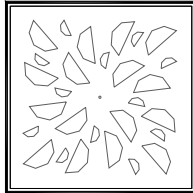

	E	A	F
400	395	369	345
500	495	469	445
600	595	569	545
610	605	579	555
625	620	594	570
675	670	644	620
600-400	595	569	545
600-500	595	569	545
610-400	605	579	555
610-500	605	579	555
625-400	620	594	570
625-500	620	594	570
675-400	670	644	620
675-500	670	644	620

NEX-S-KLIN

Classification

NEX-S-KLIN Hinged removable core diffuser for the easy access to the installations above the ceiling with no need of tools, by means of PUSH fasteners.

By slightly pressing on the invisible latch, the core opens, remaining hinged on one side. If necessary the core can be easily removed for maintenance of HVAC installations.

Material

Diffuser constructed from galvanised steel and diffusion elements in ABS plastic.

NEX-S-KLIN+PLK...-R

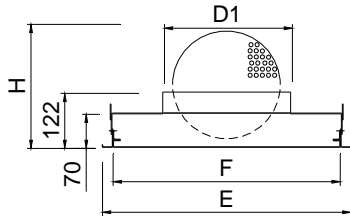

NEX-S-KLIN+PLK/L/...-R

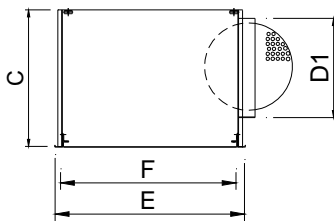

	E	F	D1	H	C
400	395	365	198	205	320
500	495	465	248	286	370
600	595	565	313	353	435
610	605	575	313	353	435
625	620	590	313	353	435
675	670	640	313	353	435

1)

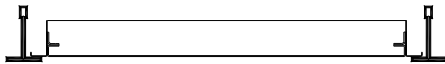

Accessories

PLK Plenum box fixed to the diffuser with an upper connection. Made in galvanised steel.

...-R Plenum box with a flow damper in the spigot.

.../L/ Plenum box with a lateral connection.

.../AIS/ Thermally insulated plenum box with foam. Density 30 kg / m³ ISO 845. Thermal conductivity 20° C_0,040 W / m°K ISO 3386/1. Classified reaction to fire B-s2, d0 EN 13501-1.

Fixing systems

1) Fixing with supports to hang from the ceiling with drops rods.

Finishes

M9016 Painted in white similar to RAL 9016.

R9010 Painted in white RAL 9010.

RAL... Painted in other RAL colours.

.../EB/ ABS plastic elements in white.

.../EL/ ABS plastic elements in lavender blue.

.../EV/ ABS plastic elements in pistachio green.

.../ER/ ABS plastic elements in red.

Specification text

Supply and mounting of square swirl diffuser with fixed concave elements with hinged removable core without tools, by pressing on the invisible PUSH fasteners series **NEX-S-KLIN+PLK-R M9016 dim. (mm)** constructed from galvanised paint in white **M9016** and diffusion elements in black ABS. With upper circular connection plenum box and air flow damper in the spigot **PLK-R**.
Manufacturer **MADEL**.

NEX-C

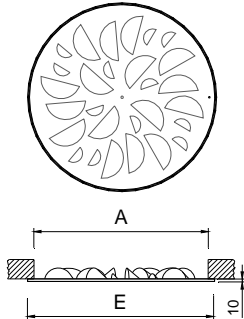

	E	A
400	400	376
500	500	476
625	625	601

NEX-C

Classification

NEX-C Circular diffuser with black ABS diffusion elements.

Material

Diffuser constructed from galvanised steel and diffusion elements in ABS plastic.

All diffusers are provided with a seal on the back of the frame in order that the perimeter in contact with the plenum box or the ceiling is airtight.

Accessories

PLXOC Plenum box with a lateral circular connection. Made in galvanised steel.

...-R Plenum box with a flow damper in the spigot.

.../S/ Plenum box with an upper connection.

.../AIS/ Thermally insulated plenum box with foam. Density 30 kg / m³ ISO 845. Thermal conductivity 20° C_0,040 W / m°K ISO 3386/1.

Classified reaction to fire B-s2, d0 EN 13501-1.

PMXO Crossbar suitable for mounting in false ceiling with rectangular duct.

PLXOC

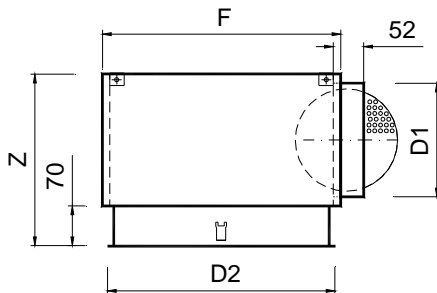

	D2	F	Z	D1
400	395	415	300	198
500	495	515	300	198
625	620	640	350	248

Fixing systems

1)

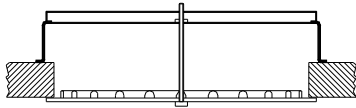

1) Connection into the crossbar or to the plenum box by means of central screw.

Finishes

1)

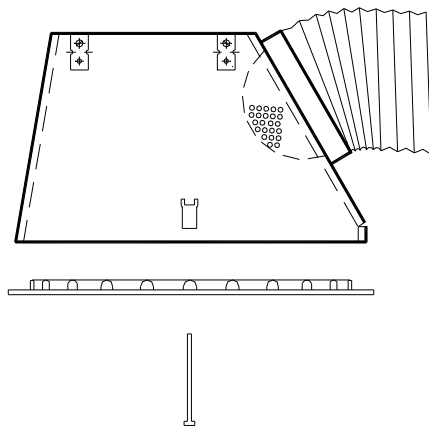

- M9016** Painted in white similar to RAL 9016.
- R9010** Painted in white RAL 9010.
- RAL...** Painted in other RAL colours.
- .../EB/** ABS plastic elements in white.
- .../EL/** ABS plastic elements in lavender blue.
- .../EV/** ABS plastic elements in pistachio green.
- .../ER/** ABS plastic elements in red.

Specification text

Supply and mounting of circular swirl diffuser with fixed concave elements in radial disposition series **NEX-G+PLXOC-R M9016 dim. 600** constructed from galvanised steel paint in white **M9016** and diffusion elements in black ABS. With lateral circular connection plenum box and air flow damper in the spigot **PLXOC-R**. Manufacturer **MADEL**.



NEX-S

(Technical data equal to 600, 610, 625 or 675)

MADEL®

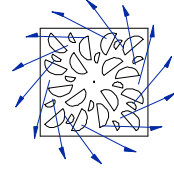

RECOMMENDED VELOCITY.

NEX-S	Vmin m/s	Vmax m/s
400	2,5	5,9
500	2,5	5,6
600	2,5	5,4
625	2,5	5,4
675	2,5	5,4

FREE FACE AREA (m2).

NEX-S	Afree m2	Qmin. m3/h	Qmax. m3/h
400	,0201	181	427
500	,029	261	585
600	,044	396	855
625	,044	396	855
675	,044	396	855

CORRECTION FACTOR FOR Dpt AND Lwa1.

BOXSTAR-R		100% Open	50% Open	10% Open
		400	Dpt (Kp) 1	1,2
	Lwa1 (Kf)	+1,6	+1,9	+1,1
500	Dpt (Kp)	1	1,2	2,3
	Lwa1 (Kf)	+1,8	+2,1	+1,1
600	Dpt (Kp)	1	1,4	4
	Lwa1 (Kf)	+2	+2,74	+1,5
625	Dpt (Kp)	1	1,5	4,8
	Lwa1 (Kf)	+2	+2,75	+1,5
675	Dpt (Kp)	1	1,5	4,8
	Lwa1 (Kf)	+2	+2,75	+1,5

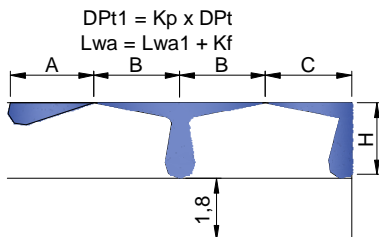

$AL_{0,2} = A$
 $AL_{0,2} = B+H$
 $AL_{0,2} = C+H$

FREE VELOCITY, PRESSURE LOSS AND SOUND POWER LEVEL, THROW WITH CEILING EFFECT. NEX-S + BOXSTAR

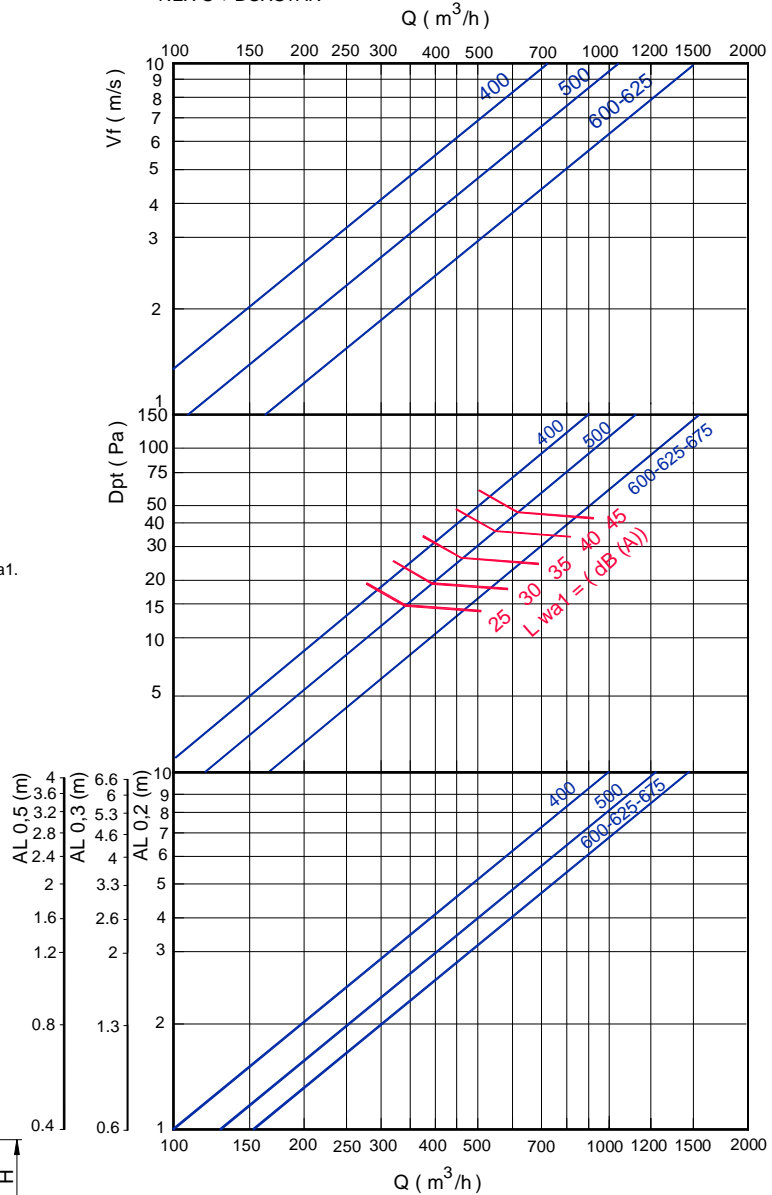



NEX-S

(Technical data equal to 600, 610, 625 or 675)

MADEL®

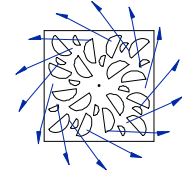

CORRECTION FACTOR FOR VERTICAL DIFFUSION (bv) FOR DT (-).

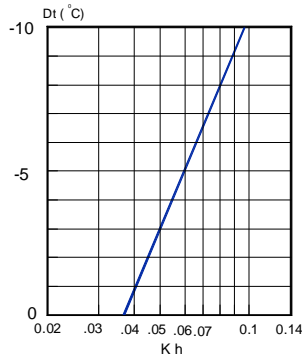

Kh = Correction factor for the vertical diffusion.

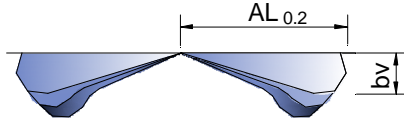

CORRECTION FACTOR FOR THROW (L0.2) DT (-).

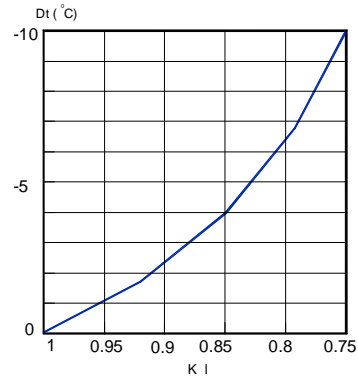

KI = Correction factor for the throw.

$$bv = Kh \times AL_{0.2}$$

$$AL'_{0.2}(Dt < 0) = KI \times AL_{0.2}$$

TEMPERATURE RATIO.

$$\frac{Dtl}{Dtz} = \frac{t_{room} - t_x}{t_{room} - t_{supply}}$$

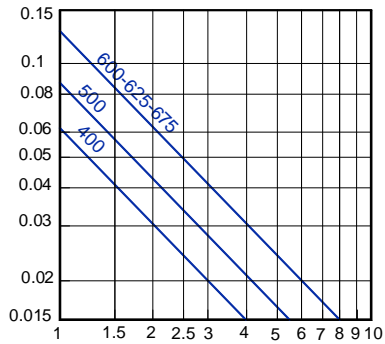

INDUCTION RATIO.

$$i = \frac{Q_r}{Q_0} = \frac{Q_{total\ at\ x}}{Q\ of\ supply}$$

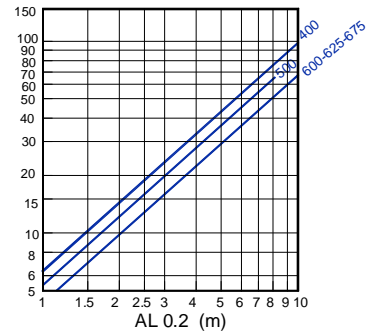



NEX-C

MADEL®

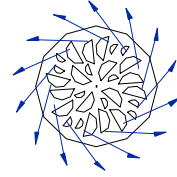

RECOMMENDED VELOCITY.

NEX-C	Vmin m/s	Vmax m/s
400	2,5	5,9
500	2,5	5,6
625	2,5	5,4

FREE VELOCITY, PRESSURE LOSS AND SOUND POWER LEVEL, THROW WITH CEILING EFFECT.

NEX-C + PLXOC Q (m³/h)

FREE FACE AREA (m²).

NEX-C	Afree m ²	Qmin. m ³ /h	Qmax. m ³ /h
400	,0201	181	427
500	,029	261	585
625	,044	396	855

CORRECTION FACTOR FOR Dpt AND Lwa1.

PLXOC-R		100% Open	50% Open	10% Open
		400	Dpt (Kp) 1	1,2
	Lwa1 (Kf) +1,6	+1,9	+1,1	
500	Dpt (Kp) 1	1,2	2,3	
	Lwa1 (Kf) +1,8	+2,1	+1,1	
625	Dpt (Kp) 1	1,4	4	
	Lwa1 (Kf) +2	+2,74	+1,5	

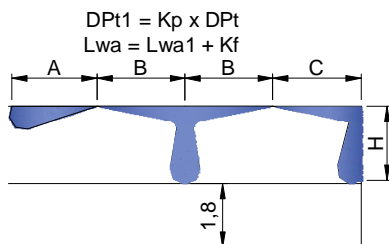
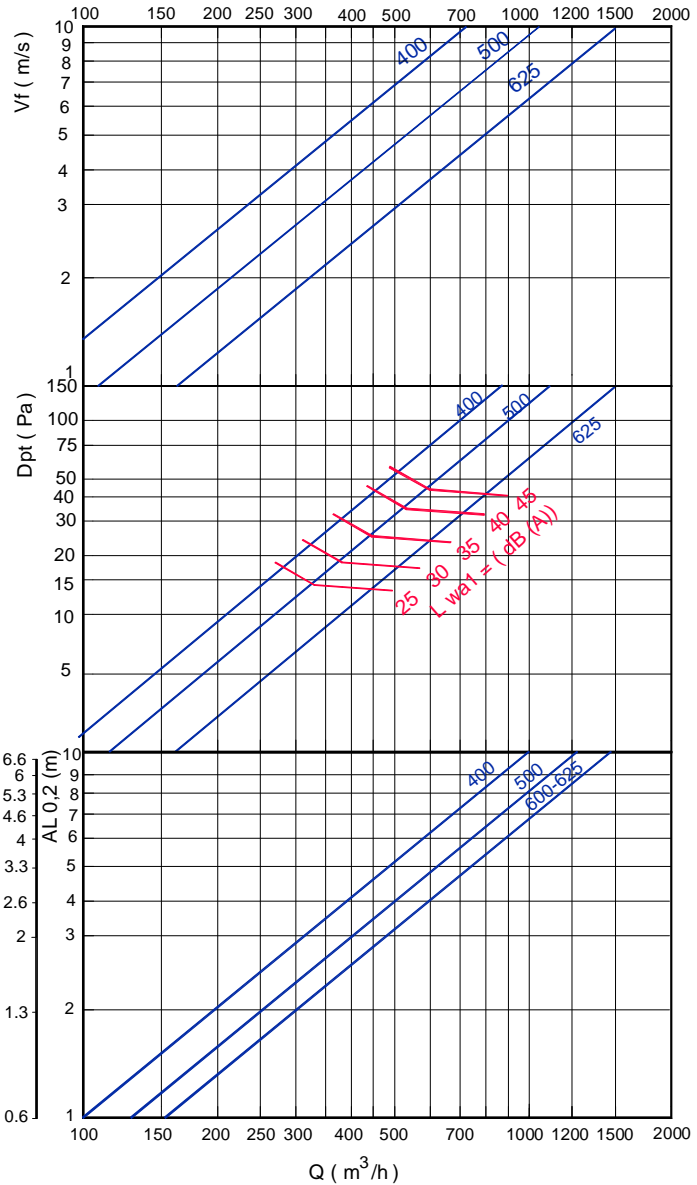

$AL_{0.2} = A$
 $AL_{0.2} = B+H$
 $AL_{0.2} = C+H$

Note: In MadelMedia Octava band centre frequency in Hz.



NEX-C

MADEL®

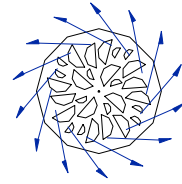

CORRECTION FACTOR FOR VERTICAL DIFFUSION (bv) FOR DT (-).

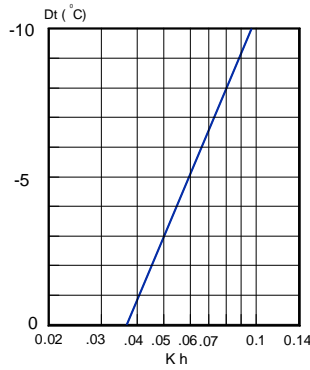

Kh = Correction factor for the vertical diffusion.

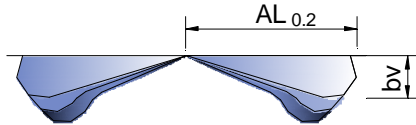

TEMPERATURE RATIO.

$$\frac{Dtl}{Dtz} = \frac{t_{\text{room}} - t_x}{t_{\text{room}} - t_{\text{supply}}}$$

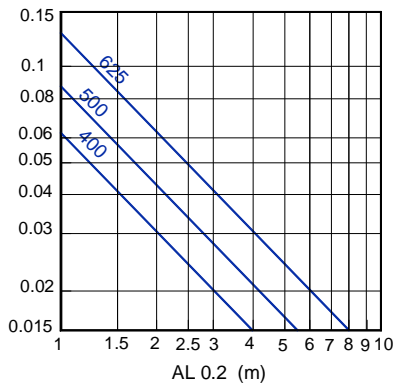

CORRECTION FACTOR FOR THROW (L0.2) DT (-).

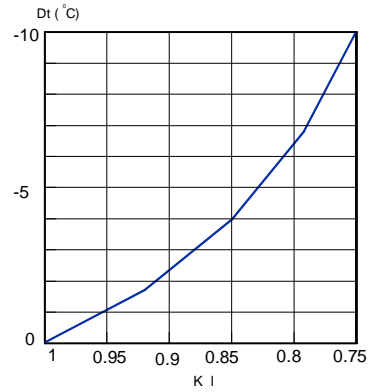

Kl = Correction factor for the throw.

$$bv = Kh \times AL_{0.2}$$

$$AL'_{0.2} (Dt < 0) = Kl \times AL_{0.2}$$

INDUCTION RATIO.

$$i = \frac{Q_r}{Q_0} = \frac{Q_{\text{total at } x}}{Q_{\text{of supply}}}$$

