



► Katherm QK, QK nano
Trench Heating

Katherm QK Katherm QK nano

Trench heating with
energy-efficient EC tangential fans

► **Technical Catalogue**

KAMPMANN

kampmanngroup.com/katherm-qk
kampmanngroup.com/katherm-qk-nano
Kampmann.co.uk/katherm-qk
Kampmann.co.uk/katherm-qk-nano

Contents

Katherm QK, QK nano at a glance	6
‣ Product information, Katherm QK, QK nano	7
‣ Product data, Katherm QK, QK nano	8
‣ Selection guide: Overview of models	9
Katherm QK nano	10
‣ Katherm QK nano at a glance	10
‣ Grilles	12
02 ‣ Technical data	14
‣ Advice on measuring conditions	15
‣ 24 V electromechanical model	16
‣ 230 V electromechanical model or KaControl	18
03 ‣ Design information	20
‣ Information on planning and design	21
‣ Hydraulic installation	22
04 ‣ Controls	23
‣ 24 V electromechanical model	23
‣ 230 V electromechanical model	25
‣ KaControl model	27
05 ‣ Ordering information	32
‣ Katherm QK nano	32
‣ Accessories	33
Katherm QK	36
‣ Katherm QK at a glance	36
‣ Grilles	38
02 ‣ Technical data	40
‣ Advice on measuring conditions	41
‣ Katherm QK 190	42
‣ Katherm QK 215	46
03 ‣ Design information	50
‣ Information on planning and design	51
‣ Katherm QK – Supply air modules ZL	52
‣ Hydraulic installation	54
04 ‣ Controls	55
‣ 24 V electromechanical model	55
‣ 230 V electromechanical model	57
‣ KaControl model	59
05 ‣ Ordering information	62
‣ Katherm QK	62
‣ Accessories	63



Plenty of heat from
minimal dimensions.



Arup Office Dublin, Ireland:
New milestone on the Grand Canal Dock.
Expansion of a listed building to become
an administration centre.

01 ▶ At a glance



Katherm QK, QK nano – compact, powerful, quiet

Heaters positioned in front of windows are often unacceptable for aesthetic reasons in modern offices and other buildings with large glazed windows. At the same time, the demands of the users in terms of the aesthetics of the space are also becoming more exacting.

Katherm QK, QK nano excel in particular with low water temperatures when combined with modern heating systems thanks to their compact design, energy-saving and whisper-quiet fans with EC motors and by high-performance convectors. Narrow trench widths of only 165, 190 and 215 mm enable (almost) unrestricted use of the floor space. Fitted with the most modern EC technology, the heat outputs from every width of Katherm QK, QK nano are impressive. Measurements and CFD simulations undertaken in the Kampmann Research & Development Centre helped to develop a sound-optimised floor trench, which helps to create a pleasant interior climate.

Function

Air is drawn in by the fan and routed through the parallel convector. The convector arranged on the window side provides for optimum screening of cold air in front of the window. The stream of warm air thus flows draught-free into the room.

EC technology

EC motors can be operated within a significantly wider speed range due to their intelligent integrated power electronics. Low speeds generate only very low noise, partially far below the audible threshold or the usual measuring range. They means that people can spend time peacefully in living rooms, offices and hotel bedrooms. The intelligent motor management permanently detects the operating state and keeps the pre-set speed constant, regardless of the fan length and external influences.

Fans

The cross-flow fans are matched to the application, optimised in terms of air flow and are adapted to the length of the convectors.

Control

There are three different control schemes available for the Katherm QK and Katherm QK nano for ease of integration into individual control schemes. The space-saving 24 V versions permits direct connection to on-site building management systems. An electromechanical control option using a room thermostat or alternatively the KaControl system are both available for continuously variable control with 230 V supply voltage. KaControl represents the system solution for maximum energy efficiency, limitless integration options into building automation systems and the highest degree of user-friendly operating philosophy.

Katherm QK 190

(Installed in screed, trench height 112 mm)

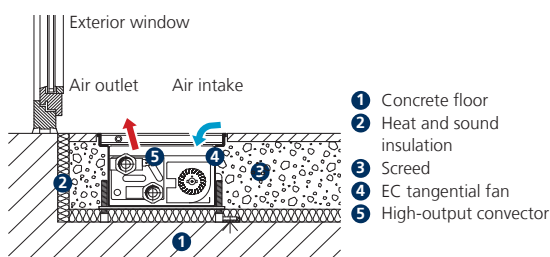

Installation example showing QK nano

(Installed in a raised floor, trench height 70 mm)

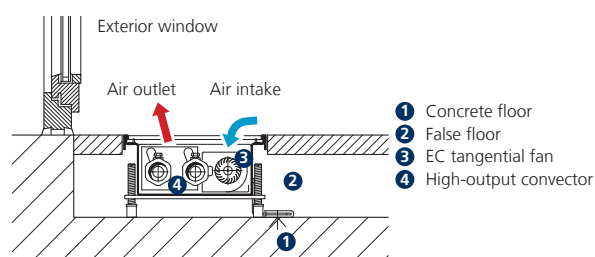

Product data, Katherm QK, QK nano



Product benefits

- ▶ whisper-quiet EC technology
- ▶ shallower depths and high outputs
- ▶ complete adaptation to building contours

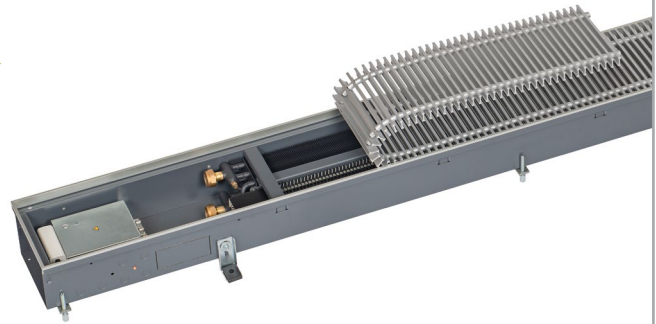

Features

Standard range

Katherm QK nano:

1 trench width each with 5 trench lengths, 1 trench height, 3 control options.

Katherm QK:

2 trench widths, 12 trench lengths, 1 trench height, 3 control options.

Notwithstanding the standard range (NP), the products can also be individually manufactured in line with the non-standard program (MP).

- Convection** ▶ EC tangential fan
- Heating** ▶ LPHW
- Cooling** ▶ ---
- Ventilation** ▶ ---
- KaControl System** ▶ integrated
- ▶ 2-pipe

Grille finishes

Katherm QK nano:

- ▶ FineLine Q (orthogonal grille)
- ▶ FineLine L (linear grille)
- ▶ bar spacing 4.8 mm

Katherm QK:

- ▶ Optiline roll-up grilles
- ▶ Optiline lines grilles
- ▶ aluminium brass, bar spacing 12 mm (9 mm optional); stainless steel, bar spacing 10.5 mm

Performance data

Heat output¹⁾ [W]

- ▶ 248-6025

Sound pressure level²⁾ [dB(A)]

- ▶ 20–41

Sound power level [dB(A)]

- ▶ 28–49

Applications

All areas of buildings in which effective heating and cold air screening is required. Effective, energy-saving heating can be provided by Katherm QK in conjunction with modern heating systems.



Hotels/
motels



Sales rooms
and
showrooms



Office and
meeting
rooms



Homes and
conservatories



Restaurants
and cafés

¹⁾ At LPHW 75 / 65°C, $t_{L1} = 20^\circ\text{C}$, with fan-assisted convection

²⁾ The sound pressure levels were calculated with an assumed room insulation of 8 dB(A). This corresponds to a distance of 2 m, a room volume of 100 m³ and a reverberation time of 0.5 s (in accordance with VDI 2081), at 60% fan speed.

Selection guide: overview of models

Katherm	Control option	Trench width	Trench height	Trench length	Grille	Heat output ¹⁾	Sound pressure level ²⁾	Sound power level	Further information
		[mm]	[mm]	[mm]		[W]	[dB(A)]	[dB(A)]	
QK nano	KaControl 230 V electromechanical	165	70	1100-2700	FineLine Q (orthogonal grille)	248-3524	<20 ³⁾ -41	<28 ³⁾ -49	► Page 18
QK nano	24 V electromechanical	165	70	900-2600	FineLine L (linear grille) BS 4.8 mm	248-3524	<20 ³⁾ -41	<28 ³⁾ -49	► Page 16
QK 190	KaControl 230 V electromechanical 24 V electromechanical	190	112	1000-3200	Roll-up grille Linear grille BS 12 mm ⁴⁾ , free area approx. 70%	437-5781	<20 ³⁾ -41	<28 ³⁾ -49	► Page 42
QK 215	KaControl 230 V electromechanical 24 V electromechanical	215	112	1000-3200		522-6025	<20 ³⁾ -41	<28 ³⁾ -49	► Page 46

Sectional views

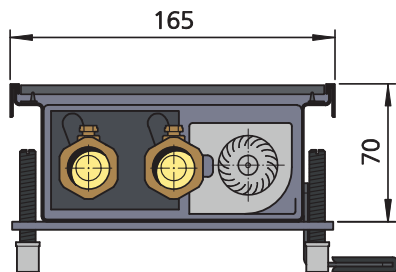

Katherm QK nano

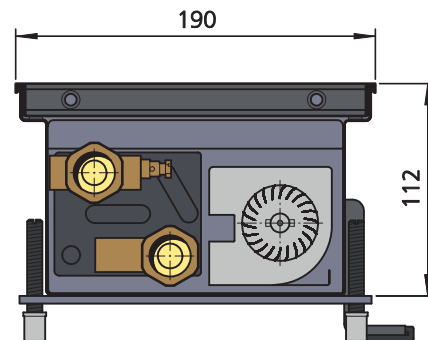

Katherm QK 190

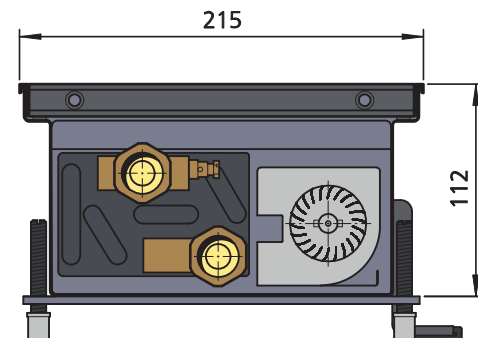

Katherm QK 215

¹⁾ At LPHW 75 / 65, $t_{11} = 20^{\circ}\text{C}$, with fan-assisted convection. The heat outputs were measured and determined in accordance with DIN EN 16430 "Fan-assisted radiators, convectors and trench heaters" Part 1: "Technical specifications and requirements" and Part 2: "Test procedures and evaluation of heat outputs".
²⁾ The sound pressure levels were calculated with an assumed room insulation of 8 dB(A). This corresponds to a clearance of 2 m, a room volume of 100 m³ and a reverberation time of 0.5 s (in accordance with VDI 2081).
³⁾ Sound pressure level < 20 dB (A) and sound power level < 28 dB (A) outside the usual measuring and audible range.
⁴⁾ Heat outputs with BS 9 mm (aluminium anodised, brass) and BS 10.5 mm (stainless steel); free area approx. 65 % can be obtained from the calculation program.

Katherm QK nano

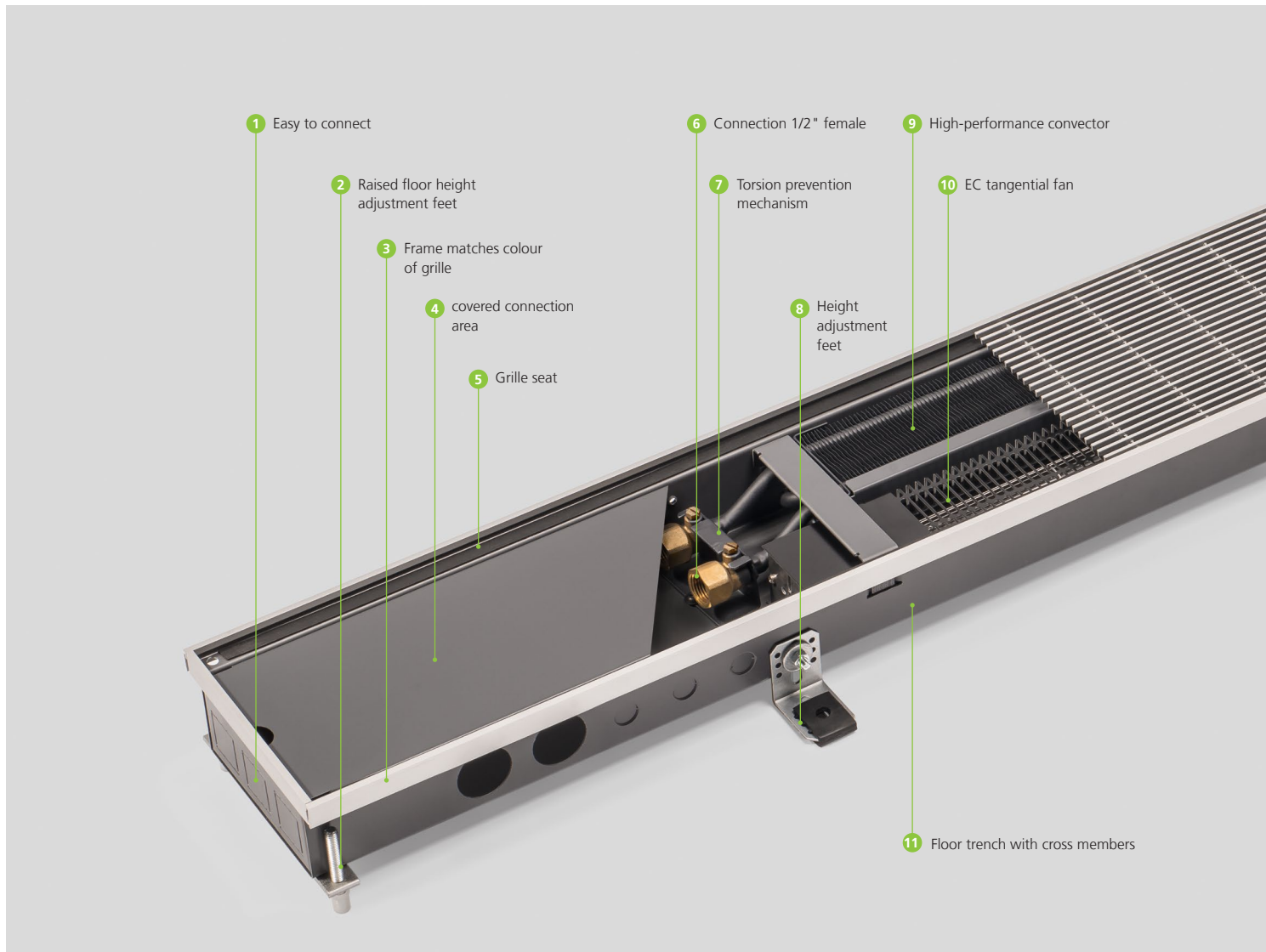

Features

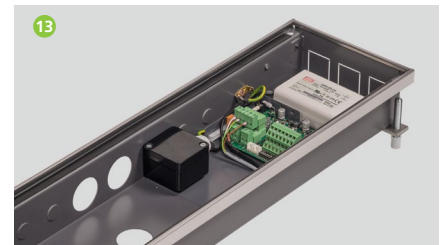
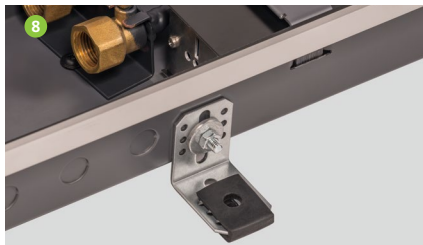
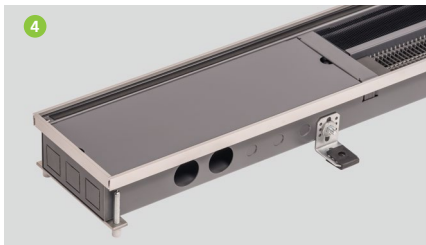

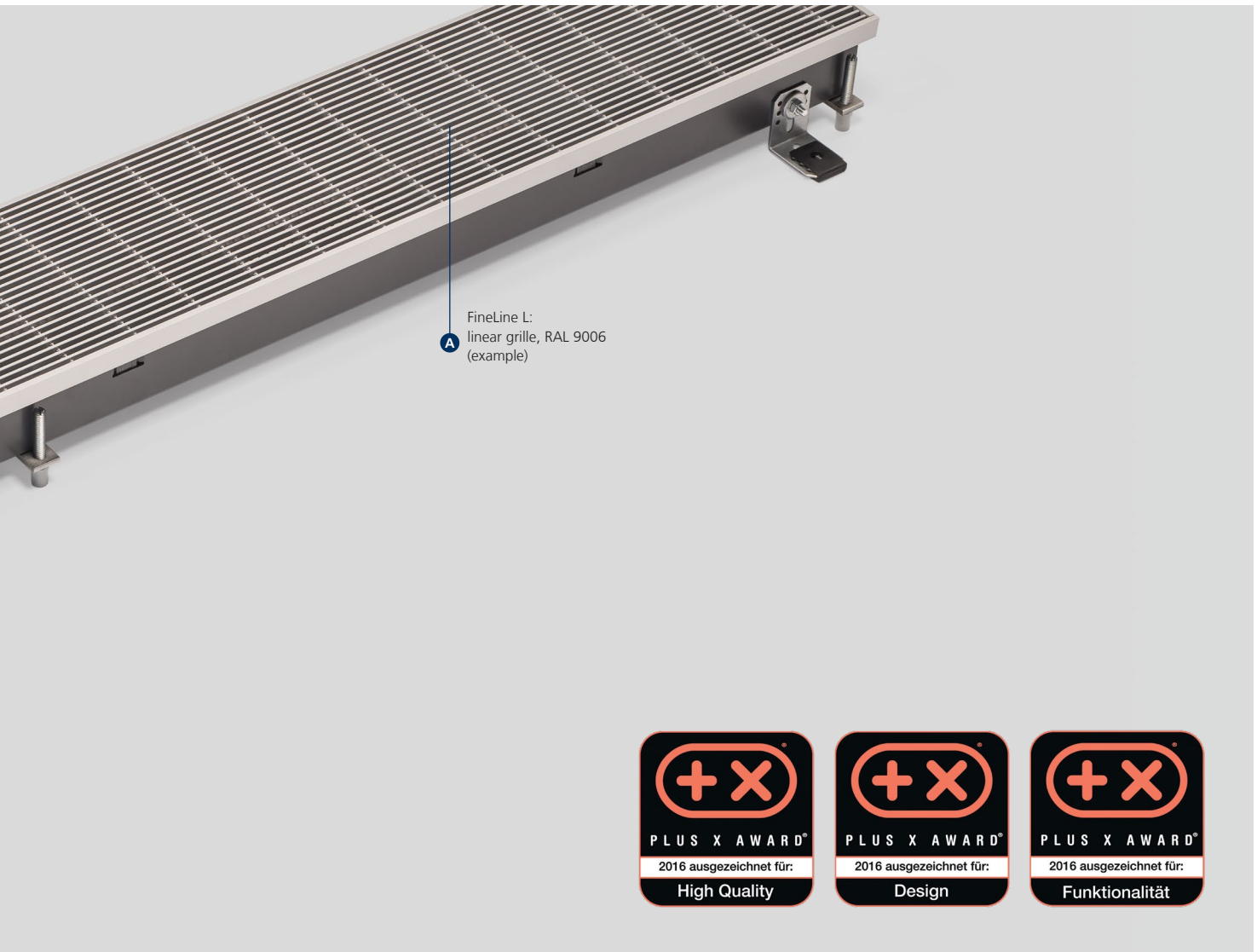

A FineLine L:
linear grille, RAL 9006
(example)



1 Easy to connect

- ▶ removable end panel for ease of connection of trenches

2 Load-bearing height adjustment feet

- ▶ for the secure mounting of the trench
- ▶ with plastic cap for acoustic decoupling

3 Frame matches colour of grille

4 Connection area

- ▶ for valves and electrical components
- ▶ with cover for visual protection and to protect against dirt

5 Grille seat

- ▶ for impact sound insulation and acoustic decoupling

6 Connection 1/2" female

- ▶ for fast connection
- ▶ space-saving

7 Torsion prevention mechanism

- ▶ prevents damage to the convector when installing the valves

8 Height adjustment feet

- ▶ for the simple fixing of the floor trench
- ▶ with rubber pad for sound insulation

9 High-performance convector

- ▶ proven combination of copper/aluminium
- ▶ optimised for air flow and heat dissipation
- ▶ graphite-grey coated

10 EC tangential fan

- ▶ for even airflow through the convector,
- ▶ robust motor design
- ▶ continuously variable speed control via an external 0 – 10V signal

11 Floor trench

- ▶ galvanised sheet steel
- ▶ graphite-grey coated on both sides
- ▶ with cross bracing to reinforce the floor trench

12 24 V electromechanical electrical connection

13 Electrical connection, electro-mechanical 230 V/KaControl

- ▶ includes 230/24 V power unit, PCB and junction box

A FineLine L: linear grille, RAL 9006 (example)

- ▶ rigid grille, airflow-optimised triangular profiles
- ▶ available as the FineLine Q (orthogonal grille) or FineLine L (linear grille)
- ▶ available in powder coated steel or natural stainless steel
- ▶ free area approx. 70%

Matching grilles

FineLine Q

Powder coated steel

RAL 9006 white aluminium

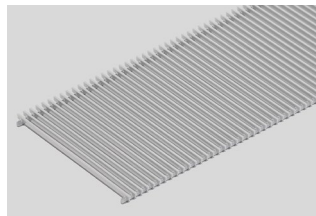

Powder coated steel

RAL 9007 grey aluminium

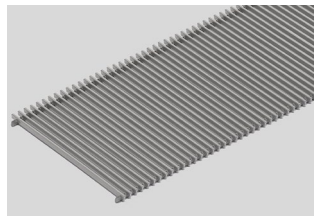

Powder coated steel

RAL 9005 black

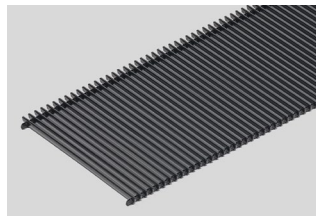

Powder coated steel

DB 703 basalt grey

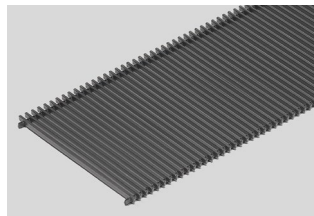

Stainless steel

Natural

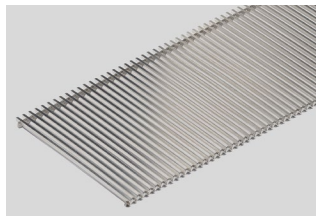

FineLine L

Powder coated steel
RAL 9006 white aluminium

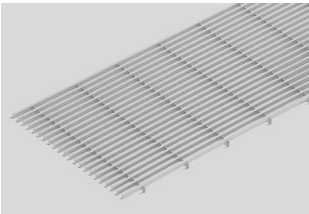

Powder coated steel
RAL 9007 grey aluminium

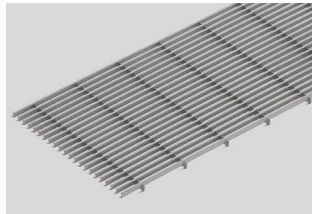

Powder coated steel
RAL 9005 black

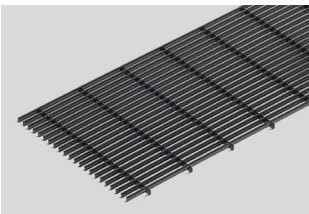

Powder coated steel
DB 703 basalt grey

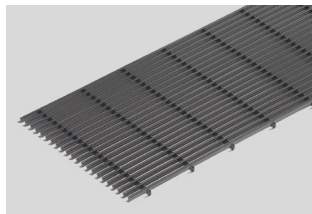

Stainless steel
Natural

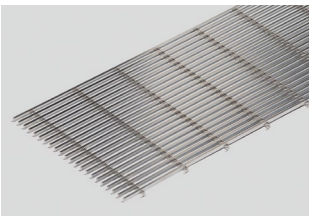

► For more grilles, please refer to
Kampmann.co.uk/grilles

The above grilles are shown using a four-colour printing process and thus do not represent an exact reproduction of the original colour.

Digram of FineLine profiles

Airflow-optimised triangular profile

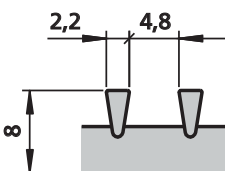

There can be slight deviations in colour between the grille and frame trim.

02 ▶ Technical data

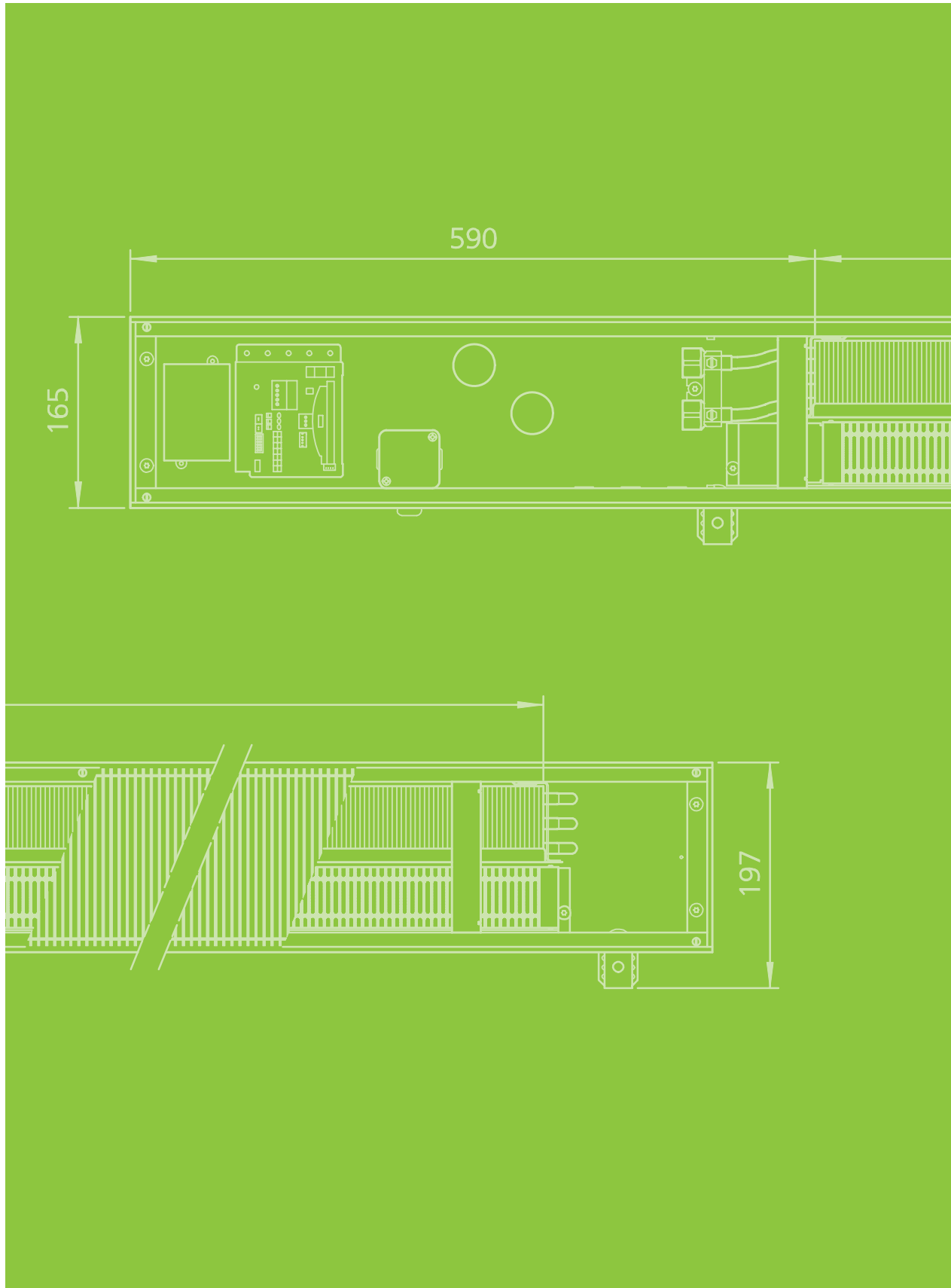

Advice on measuring conditions

Heat outputs

The heat outputs have been tested in accordance with DIN EN 16430 ("Fan assisted heaters, convectors, trench convectors").

The standard regulates the performance measurements specifically of trench convectors based on DIN EN 442. Two parts of DIN EN 16430 describe the measurement of the heat outputs.

Part 1 "Technical specifications and requirements"
Part 2 "Test method and evaluation of heat output"

The specific requirements for trench heating are taken into account in DIN EN 16430. The reference air temperature is measured in the centre of the test chamber (2 metres from the external wall) at a height of 0.75 metres. The surface temperature of the façade is 16 °C. Experience has shown that the practical distance of the trench convector from the façade is 50 mm.

Acoustics

Katherm QK nano are very often used in acoustically sensitive areas. Accordingly, Katherm QK nano have been optimised in terms of noise levels. The sound power level is measured according to DIN EN ISO 3744 in a semi-low reflective sound measuring chamber.

Air flow simulation

CFD simulations were used to support the development of the Katherm QK nano, enabling the air flows in the trench to be visualised and optimised.



Air flow laboratory

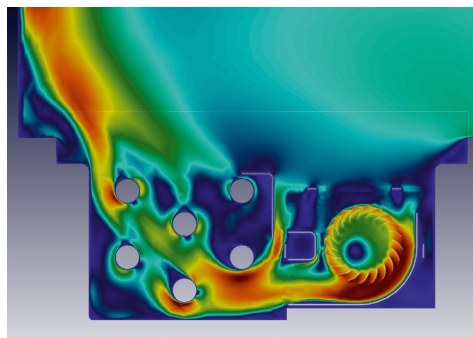

Katherm QK nano, 24 V electromechanical model

Technical drawings (all dimensions in mm)

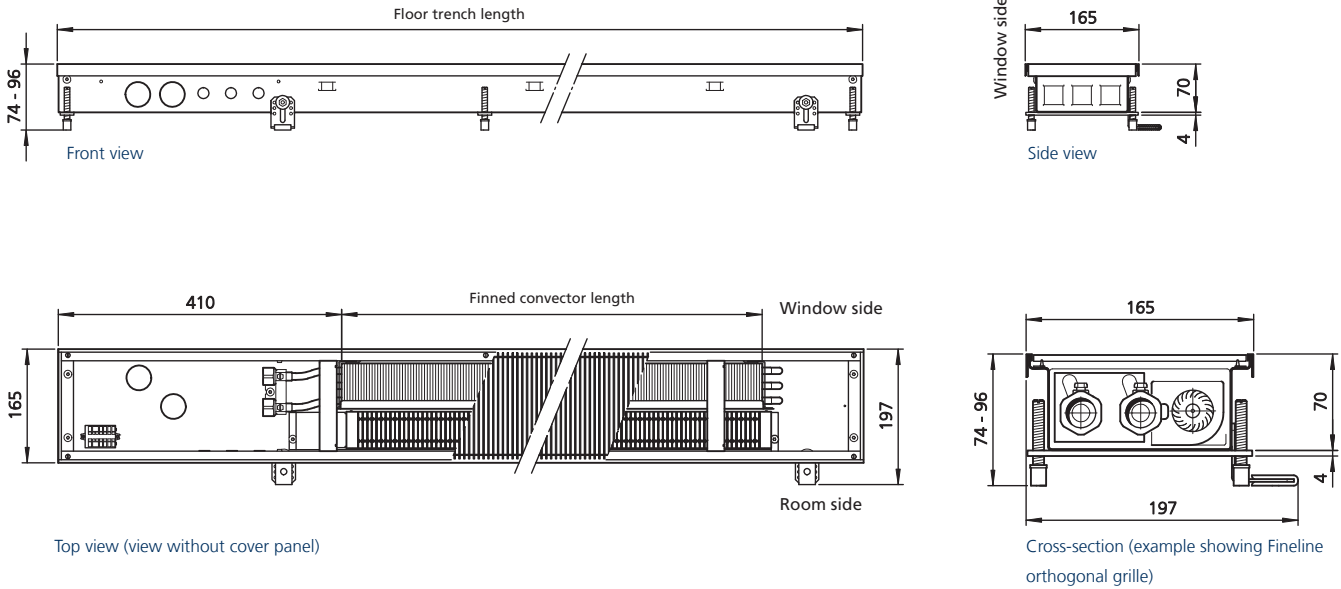

Trench length	Finned convector length
[mm]	[mm]
900	435
1400	870
1800	1305
2100	1640
2600	1985

Specifications

Connections, female thread:
1/2", same end,
connections on left

Make use of our online calculation programs to calculate your heat outputs and flow rates with a couple of clicks!

- ▶ Kampmann.co.uk/katherm-qk-nano/calculation
- ▶ Kampmann.eu/katherm-qk-nano/calculation

Water pressure drop: heating curve

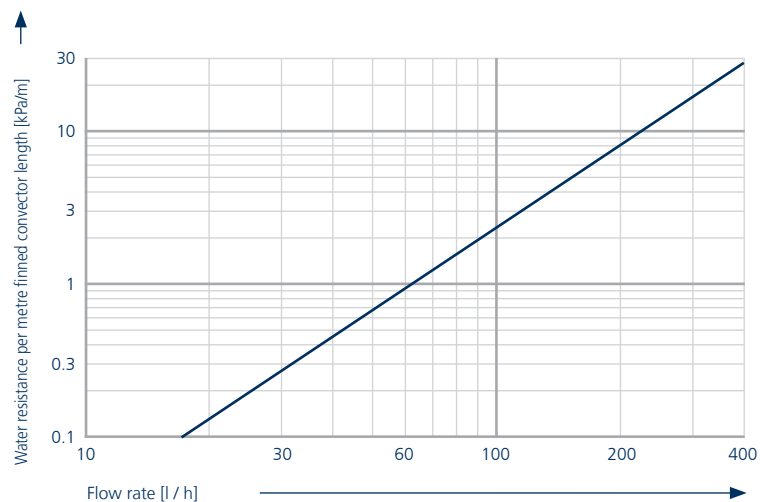

Outputs



Fan stage	at speed setting	Heat outputs ¹⁾		Power consumption ²⁾	Current consumption	Air volume	Sound pressure level ³⁾	Sound power level
		at LPHW 75 / 65 °C	at LPHW 82 / 71 °C					
	[%]	Q _N [W]	Q [W]	P [W]	I [mA]	[m ³ /h]	[dB(A)]	[dB(A)]
Trench length 900 mm								
Boost stage	100	772	874	5.0	208	75	34	42
Design levels	80	663	748	3.0	109	60	30	38
	60	539	607	2.0	63	50	22	30
	40	407	458	1.0	33	35	< 20 ⁴⁾	< 28 ⁴⁾
Minimum stage	20	248	295	1.0	17	25	< 20 ⁴⁾	< 28 ⁴⁾
Natural convection		52	61	---	---	---	---	---
Trench length 1400 mm								
Boost stage	100	1545	1748	6.0	227	155	37	45
Design levels	80	1326	1496	3.0	125	120	33	41
	60	1078	1214	2.0	75	95	25	33
	40	813	917	1.0	41	70	< 20 ⁴⁾	< 28 ⁴⁾
Minimum stage	20	496	590	1.0	23	50	< 20 ⁴⁾	< 28 ⁴⁾
Natural convection		104	121	---	---	---	---	---
Trench length 1800 mm								
Boost stage	100	2317	2621	7.0	258	230	39	47
Design levels	80	1989	2244	4.0	147	180	35	43
	60	1618	1821	3.0	89	145	27	35
	40	1220	1375	2.0	51	105	< 20 ⁴⁾	< 28 ⁴⁾
Minimum stage	20	744	885	1.0	30	75	< 20 ⁴⁾	< 28 ⁴⁾
Natural convection		156	182	---	---	---	---	---
Trench length 2100 mm								
Boost stage	100	2912	3294	8.0	333	290	40	48
Design levels	80	2499	2820	6.0	212	225	36	44
	60	2033	2288	3.0	121	180	28	36
	40	1533	1728	2.0	68	130	20	28
Minimum stage	20	935	1112	1.0	41	95	< 20 ⁴⁾	< 28 ⁴⁾
Natural convection		196	229	---	---	---	---	---
Trench length 2600 mm								
Boost stage	100	3524	3987	13.0	477	345	41	49
Design levels	80	3025	3414	7.0	265	270	37	45
	60	2461	2770	5.0	161	220	29	37
	40	1856	2092	3.0	89	160	21	29
Minimum stage	20	1132	1346	2.0	51	115	< 20 ⁴⁾	< 28 ⁴⁾
Natural convection		238	277	---	---	---	---	---

Q_N [W] = Standard heat output

Q [W] = Heat output

¹⁾ At room temperature t_L = 20 °C

²⁾ Add an additional power consumption of 1 W per valve drive type 146906.

³⁾ The sound pressure levels were calculated with an assumed room insulation of 8 dB(A). This corresponds to a clearance of 2 m, a room volume of 100 m³ and a reverberation time of 0.5 s (according to VDI 2081).

⁴⁾ Sound pressure level < 20 dB (A) and sound power level < 28 dB (A) outside the usual measuring and audible range.

Katherm QK nano, 230 V electromechanical model or KaControl

Technical drawings (all dimensions in mm)

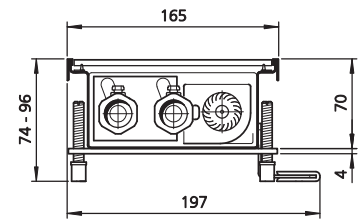
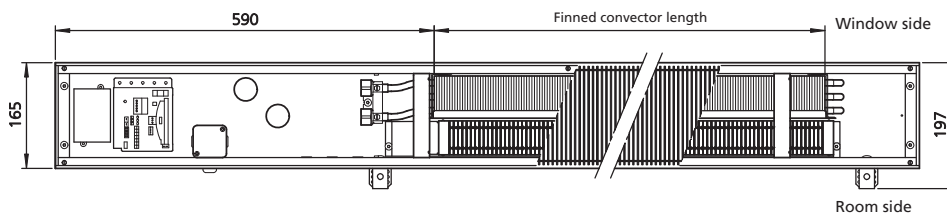
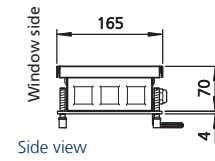
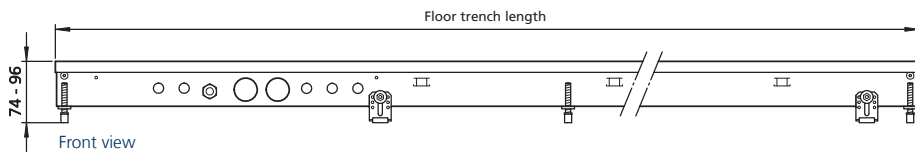

Top view (view without cover panel)

Cross-section (example showing Fineline orthogonal grille)

Trench convector length A	Finned convector length B
[mm]	[mm]
1100	435
1600	870
2000	1305
2300	1640
2700	1985

Specifications

Connections, female thread:
1/2", same end,
connections on left

Make use of our online calculation programs to calculate your heat outputs and flow rates with a couple of clicks!

- ▶ Kampmann.co.uk/katherm-qk-nano/calculation
- ▶ Kampmann.eu/katherm-qk-nano/calculation

Water pressure drop: heating curve

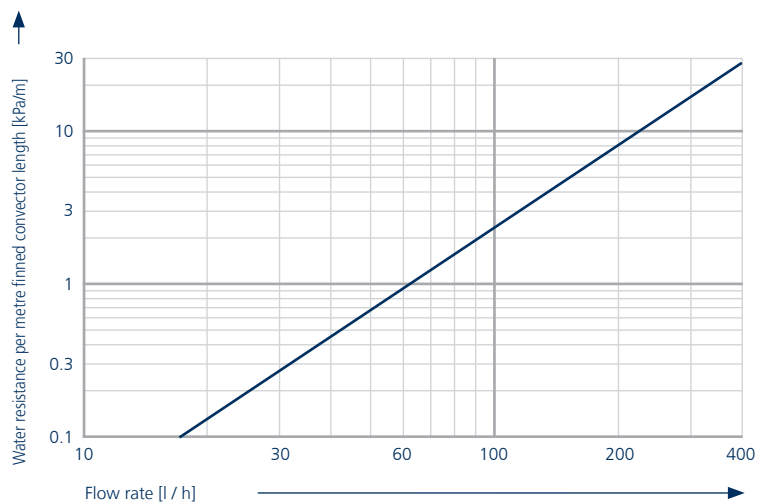

Outputs



Fan stage	at speed setting	Heat outputs ¹⁾		Power consumption ²⁾	Current consumption	Air volume	Sound pressure level ³⁾	Sound power level
		at LPHW 75 / 65 °C	at LPHW 82 / 71 °C					
	[%]	Q _N [W]	Q [W]	P [W]	I [mA]	[m ³ /h]	[dB(A)]	[dB(A)]
Trench length 1100 mm								
Boost stage	100	772	874	6.0	249	75	34	42
Design levels	80	663	748	4.0	151	60	30	38
	60	539	607	3.0	105	50	22	30
	40	407	458	2.0	74	35	< 20 ⁴⁾	< 28 ⁴⁾
Minimum stage	20	248	295	2.0	59	25	< 20 ⁴⁾	< 28 ⁴⁾
Natural convection		52	61	---	---	---	---	---
Trench length 1600 mm								
Boost stage	100	1545	1748	7.0	269	155	37	45
Design levels	80	1326	1496	4.0	166	120	33	41
	60	1078	1214	3.0	117	95	25	33
	40	813	917	2.0	83	70	< 20 ⁴⁾	< 28 ⁴⁾
Minimum stage	20	496	590	2.0	65	50	< 20 ⁴⁾	< 28 ⁴⁾
Natural convection		104	121	---	---	---	---	---
Trench length 2000 mm								
Boost stage	100	2317	2621	8.0	299	230	39	47
Design levels	80	1989	2244	5.0	188	180	35	43
	60	1618	1821	4.0	131	145	27	35
	40	1220	1375	3.0	93	105	< 20 ⁴⁾	< 28 ⁴⁾
Minimum stage	20	744	885	2.0	71	75	< 20 ⁴⁾	< 28 ⁴⁾
Natural convection		156	182	---	---	---	---	---
Trench length 2300 mm								
Boost stage	100	2912	3294	9.0	375	290	40	48
Design levels	80	2499	2820	7.0	253	225	36	44
	60	2033	2288	4.0	163	180	28	36
	40	1533	1728	3.0	110	130	20	28
Minimum stage	20	935	1112	2.0	83	95	< 20 ⁴⁾	< 28 ⁴⁾
Natural convection		196	229	---	---	---	---	---
Trench length 2700 mm								
Boost stage	100	3524	3987	14.0	561	345	41	49
Design levels	80	3025	3414	8.0	349	270	37	45
	60	2461	2770	6.0	244	220	29	37
	40	1856	2092	4.0	173	160	21	29
Minimum stage	20	1132	1346	3.0	134	115	< 20 ⁴⁾	< 28 ⁴⁾
Natural convection		238	277	---	---	---	---	---

Q_N [W] = Standard heat output

Q [W] = Heat output

¹⁾ At room temperature t_L = 20 °C

²⁾ Add an additional power consumption of 1 W per valve drive type 146906.

³⁾ The sound pressure levels were calculated with an assumed room insulation of 8 dB(A). This corresponds to a clearance of 2 m, a room volume of 100 m³ and a reverberation time of 0.5 s (according to VDI 2081).

⁴⁾ Sound pressure level < 20 dB (A) and sound power level < 28 dB (A) outside the usual measuring and audible range.

03 ▶ Design information



Information on planning and design

Katherm QK nano are suitable for buildings of all kinds that require heating but have only limited space available in the floor.

In spite of their shallow height, Katherm QK nano can meet high heat loads in a space with assistance from whisper-quiet EC tangential fans.

They are generally positioned directly in front of the external façade without a gap. Katherm QK nano can provide cost-effective and efficient heating, particularly in front of large areas of glazing.

Air outlet

All Katherm QK nano are positioned with the convector on the window side. The warm air rising up the exterior façade flows draught-free into the room, guaranteeing optimum cold air screening.

Acoustics

The respective sound power levels of Katherm QK nano are indicated in the tables (see "Technical data"). The sound pressure levels were calculated with an assumed room insulation of 8 dB(A). This corresponds to a distance of 2 m, a room volume of 100 m³ and a reverberation time of 0.5 s (in accordance with VDI 2081).

As the sound pressure level is not only due to the Katherm QK nano, but is also influenced by the number of Katherm QK nano and also very significantly by the acoustic characteristics of the room, the actual figure may vary in practice.

We would recommend designing Katherm QK nano taking into account the respective permitted sound pressure level in the room.

Heat outputs

The heat outputs were calculated based on DIN EN 16430. We would recommend our online calculation programs to convert to other operating conditions at:
kampmann.co.uk/katherm-qk-nano/calculation
kampmann.eu/katherm-qk-nano/calculation

Make use of our online calculation programs to calculate your heat outputs and flow rates with a couple of clicks!

- ▶ Kampmann.co.uk/kathermqknano/calculation
- ▶ Kampmann.eu/kathermqknano/calculation

Hydraulic set-up

Each model of the Katherm QK nano (24 V electromechanical, 230 V electromechanical or KaControl) offers two hydraulic set-up options with the optional accessory kits type 442100 and type 442101. Valve kit type 442100 can be used if valve control is planned in the trench convector. If the hydraulic system

is to be controlled via a central heating circuit distributor, connection kit type 442101 can be used to shut off the copper-aluminium convector.

Decentralised valve control

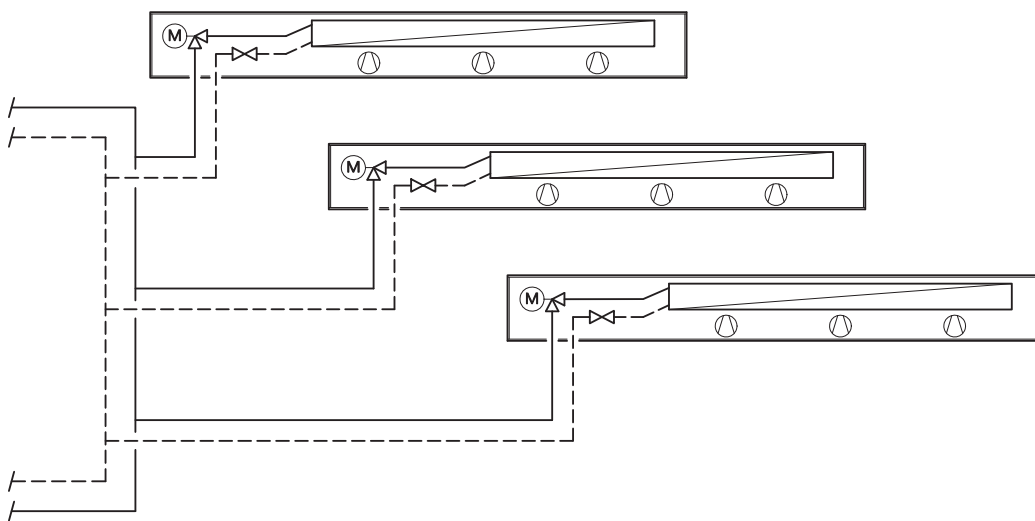

Valve kit type 442100 must be ordered separately.

Central heating circuit distributor

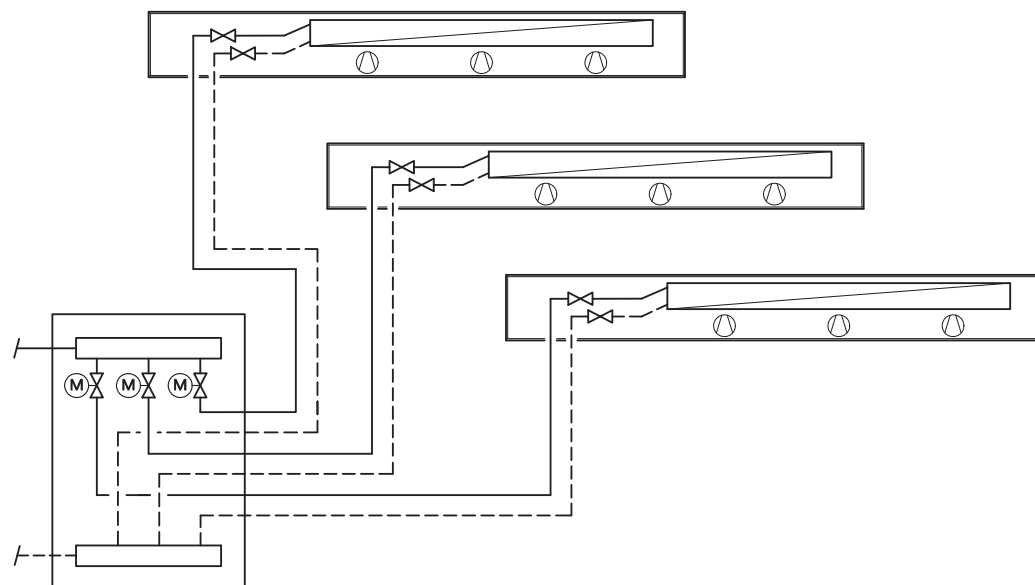

Valve kit type 442101 must be ordered separately.

04 ▶ Controls

Three different control options are available for the Katherm QK nano for ease of integration into individual control schemes. The space-saving 24 V versions permits direct connection to on-site building management systems. An electromechanical control option using a room thermostat or alternatively the KaControl system are both available for continuously

variable control with 230 V supply voltage. KaControl represents the system solution for maximum energy efficiency, limitless integration options into building automation systems and the highest degree of user-friendly operating philosophy.

24 V electromechanical model

Model for complete on-site control of trench convectors.

Product features

- ▶ The operating voltage must be provided by a central on-site 24 V DC voltage supply.
- ▶ The external voltage supply results in a shortened, space-saving connection area within the trench convector, producing the same output from a shorter trench length.
- ▶ Kampmann offers a range of switching power units in different output classes as accessories for the voltage supply (24 V DC).
- ▶ The fan automatically switches off in the event of a motor fault.

Table with rating values

Trench length [mm]	QK nano Power consumption P [W] Current consumption I [mA] at fan speed									
	20%		40%		60%		80%		100%	
900	1.0	17	1.0	33	2.0	63	3.0	109	5.0	208
1400	1.0	23	1.0	41	2.0	75	3.0	125	6.0	227
1800	1.0	30	2.0	51	3.0	89	4.0	147	7.0	258
2100	1.0	41	2.0	68	3.0	121	6.0	212	8.0	333
2600	2.0	51	3.0	89	5.0	161	7.0	265	13.0	477

The power and current consumption of the actuators (1 W) is not taken into account.

Electrical cabling - BMS control

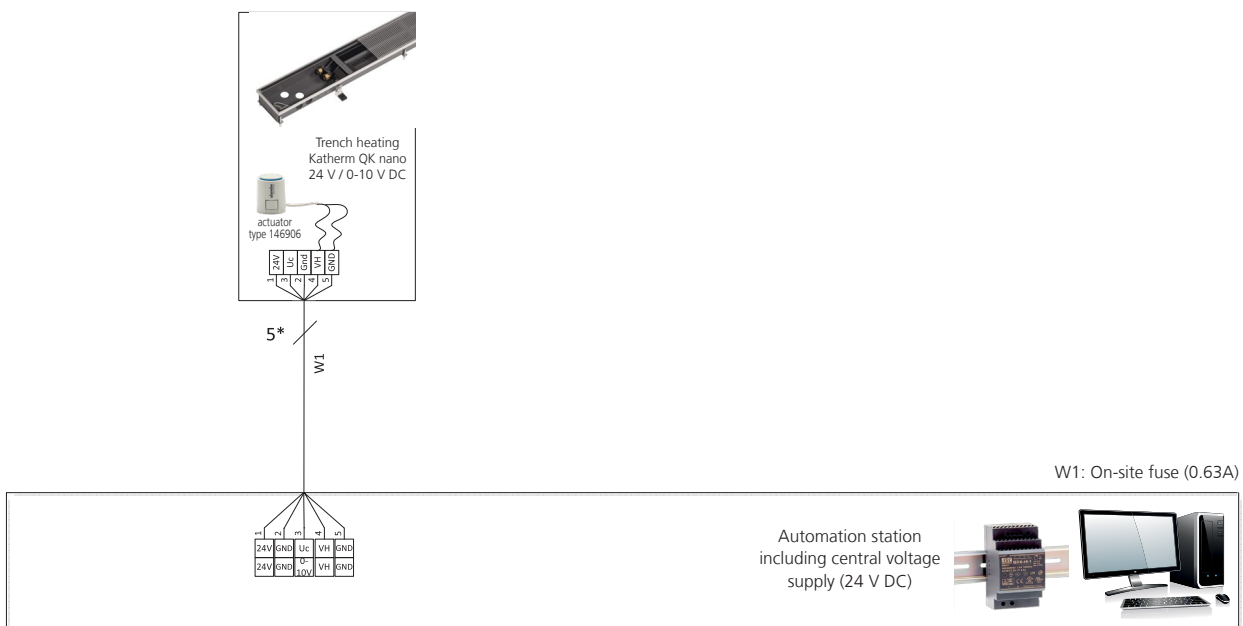

* Lay shielded cables (e.g. IY(ST)Y, 0.8 mm), separately from high-voltage cables.

W1: Voltage supply and control signal for fan (on-site fuse 0.63 A) and actuator.

Subject to technical modifications: Refer to the control accessory documentation in the event of deviation from the circuit diagrams!

Electrical cabling – control via clock thermostat, type 30456

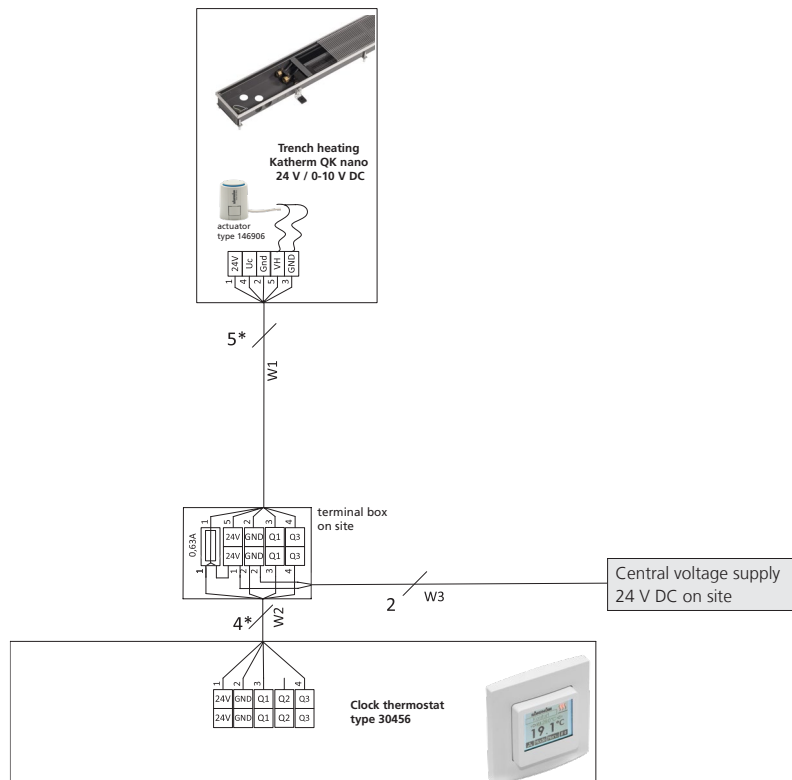

- * Lay shielded cables (e.g. IY(ST)Y, 0.8 mm), separately from high-voltage cables.
- W1: Voltage supply and control signal for fan (on-site fuse 0.63 A) and actuator.
- W2: Voltage supply and control signal for fan and actuator.
- W3: Voltage supply (fuse by others).

230 V electromechanical model

Design for on-site control or for room regulation with intuitive operation of the trench convectors.

Product features

- ▶ The Katherm QK nano features an integral switch power supply to connect to the 230 V AC voltage supply.
- ▶ In the event of a motor fault, the fan automatically switches off and a fault signal is issued at a potential-free contact.
- ▶ Kampmann offers an extensive range of control accessories for all required functions.

Table with rating values

Trench length [mm]	QK nano Power consumption P [W] Current consumption I [mA] at fan speed									
	20%		40%		60%		80%		100%	
1100	2.0	59	2.0	74	3.0	105	4.0	151	6.0	249
1600	2.0	65	2.0	83	3.0	117	4.0	166	7.0	269
2000	2.0	71	3.0	93	4.0	131	5.0	188	8.0	299
2300	2.0	83	3.0	110	4.0	163	7.0	253	9.0	375
2700	3.0	134	4.0	173	6.0	244	8.0	349	14.0	561

The power and current consumption of the actuators (1 W) is not taken into account.

Electrical cabling - BMS control

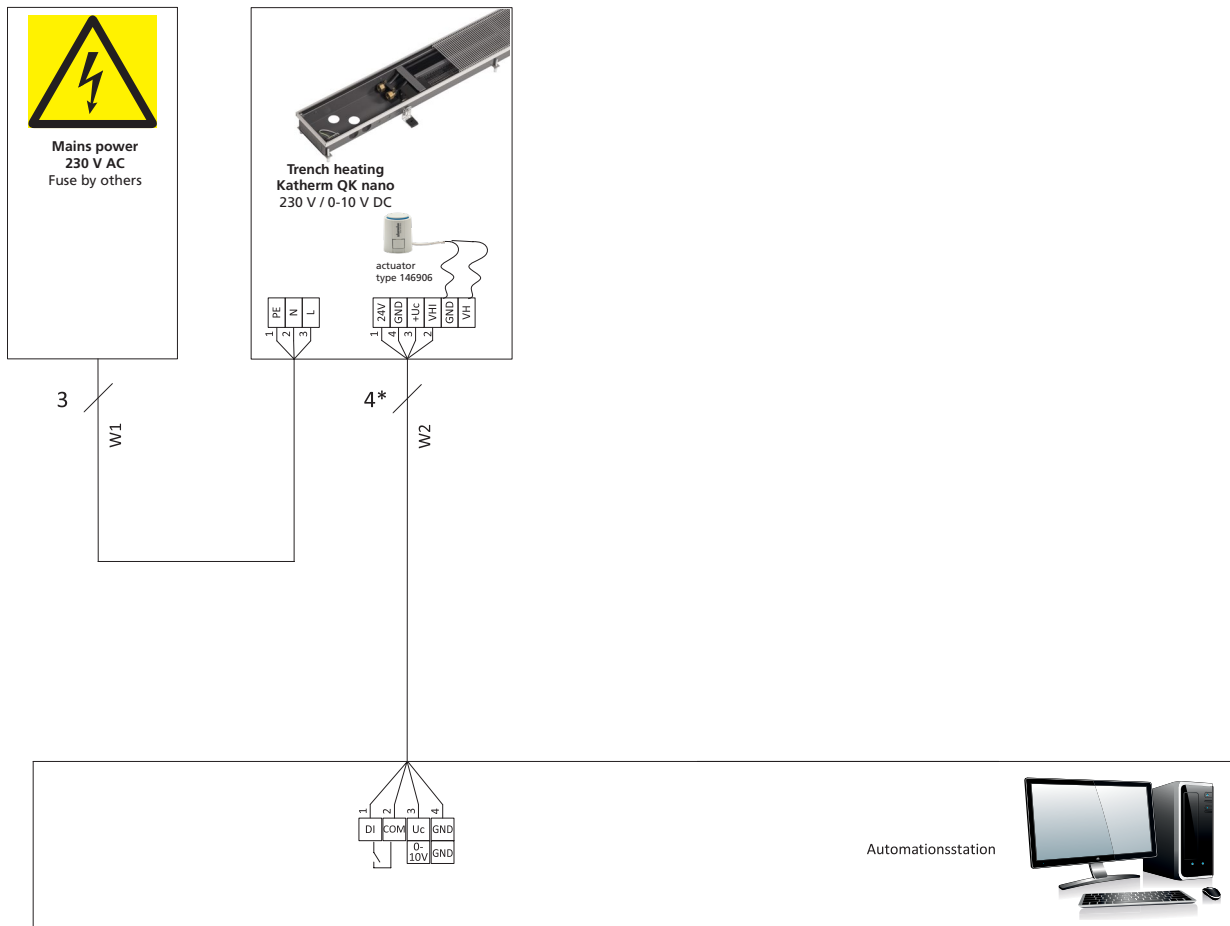

* Lay shielded cables (e.g. IY(ST)Y, 0.8 mm), separately from high-voltage cables.

W1: Power supply

W2: Control signal for fan and actuator

Subject to technical modifications: Refer to the control accessory documentation in the event of deviation from the circuit diagrams!

Electrical cabling – control via room thermostat, type 342924

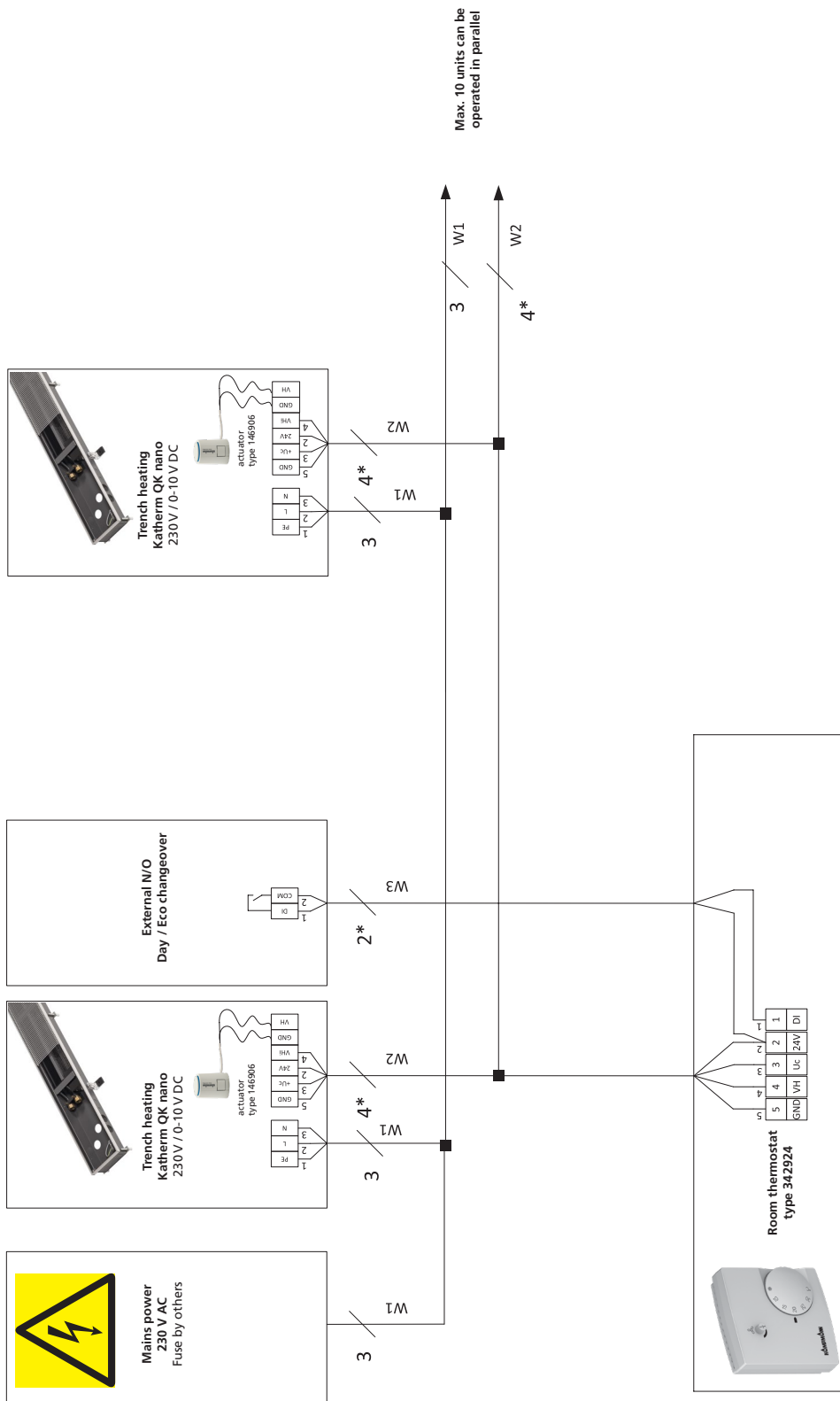

* Lay shielded cables (e.g. IY(ST)Y, 0.8 mm), separately from high-voltage cables.

W1: Power supply

W2: Control signal for fan and actuator

W3: Operating mode changeover (optional)

Subject to technical modifications: Refer to the control accessory documentation in the event of deviation from the circuit diagrams!

KaControl model

The all-inclusive solution for room automation and networking

Product features

- ▶ A high-performance parametrised microprocessor is designed to carry out all necessary functions. Each Katherm QK nano unit therefore is equipped with its own "intelligence" and can be operated in groups via Kampmann networks.

Connection to building automation systems

- ▶ Katherm QK nano units with KaControl can be equipped with plug-in communication interfaces for individual room control or for linking into higher-order control systems: BACnet, CAN bus, LON, KNX and Modbus. Direct control via an active 0-10 V signal from the on-site building management system is alternatively possible.

Motor protection

- ▶ Any faults with the motor e.g. overloading are analysed by the electronics within the EC motor. This then switches the fan off.

KaControl

The parametrisable KaControl offers a wide range of functions:

- ▶ optional: 5 fan speed settings; manually adjustable
- ▶ valve control for 2-pipe applications for thermoelectric valve actuators 24 V DC OPEN/CLOSE
- ▶ integrated timer program for programming day and week switching functions in the KaController unit
- ▶ motor monitoring with fault signal processing

KaController operating unit



The "face" of the KaControl building automation system: the KaController operating unit.

With a large display and one-touch operation, the KaController is very easy to use. With the basic principle, "as little as possible, as much as required", even untrained users can intuitively get to grips with the control options.

The basic functions for comfortable interior temperatures are set in a user-friendly way using the KaController.

Product features

- ▶ room control unit, wall-mounted, high-grade design
- ▶ available with or without function buttons on the side
- ▶ plastic housing, colour similar to RAL 9010
- ▶ communication interface to Kampmann T-LAN bus system
- ▶ large display with automatic back light
- ▶ integral room temperature sensor
- ▶ push-turn navigator dial with endless turn/lock function
- ▶ built-in weekly switching program
- ▶ password-protected parameter level

Table with rating values

Trench length [mm]	QK nano Power consumption P [W] Current consumption I [mA] at fan speed									
	20%		40%		60%		80%		100%	
1100	2.0	59	2.0	74	3.0	105	4.0	151	6.0	249
1600	2.0	65	2.0	83	3.0	117	4.0	166	7.0	269
2000	2.0	71	3.0	93	4.0	131	5.0	188	8.0	299
2300	2.0	83	3.0	110	4.0	163	7.0	253	9.0	375
2700	3.0	134	4.0	173	6.0	244	8.0	349	14.0	561

The power and current consumption of the actuators (1 W) is not taken into account.

Electrical cabling - 24 V Open / Close valve, external KaController

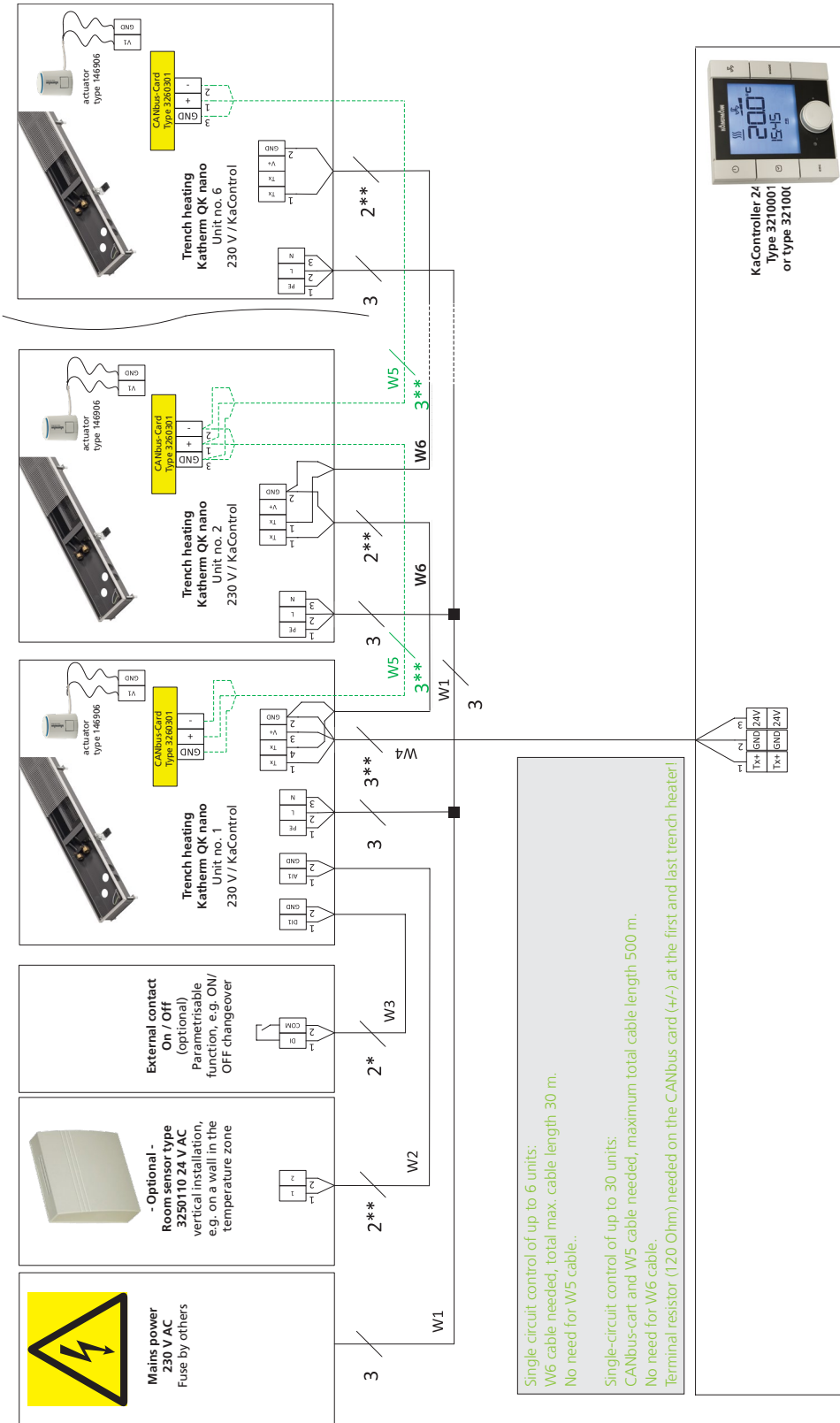

* Lay shielded cables (e.g. IY(ST)Y 0,8 mm) separately from high-voltage cables.

** Lay shielded, paired cables, e.g. UNITRONIC® BUS LD 2x2x0,22 or equivalent, separately from high-voltage cables.

W1: Power supply

W2: Analogue input AI1 (optional connection), max. cable length 10 m, from 1 mm² 30 m.

W3: Digital input DI1 (optional connection), max. cable length 30 m, from 1 mm² 100 m.

W4/W6: Bus signal (tLan), each max. total cable length 30 m.

W5: Bus signal (CANbus) only needed in a single-circuit control of up to 30 units.

Subject to technical modifications: Refer to the control accessory documentation in the event of deviation from the circuit diagrams!

Cabling with control electronics type 3231132

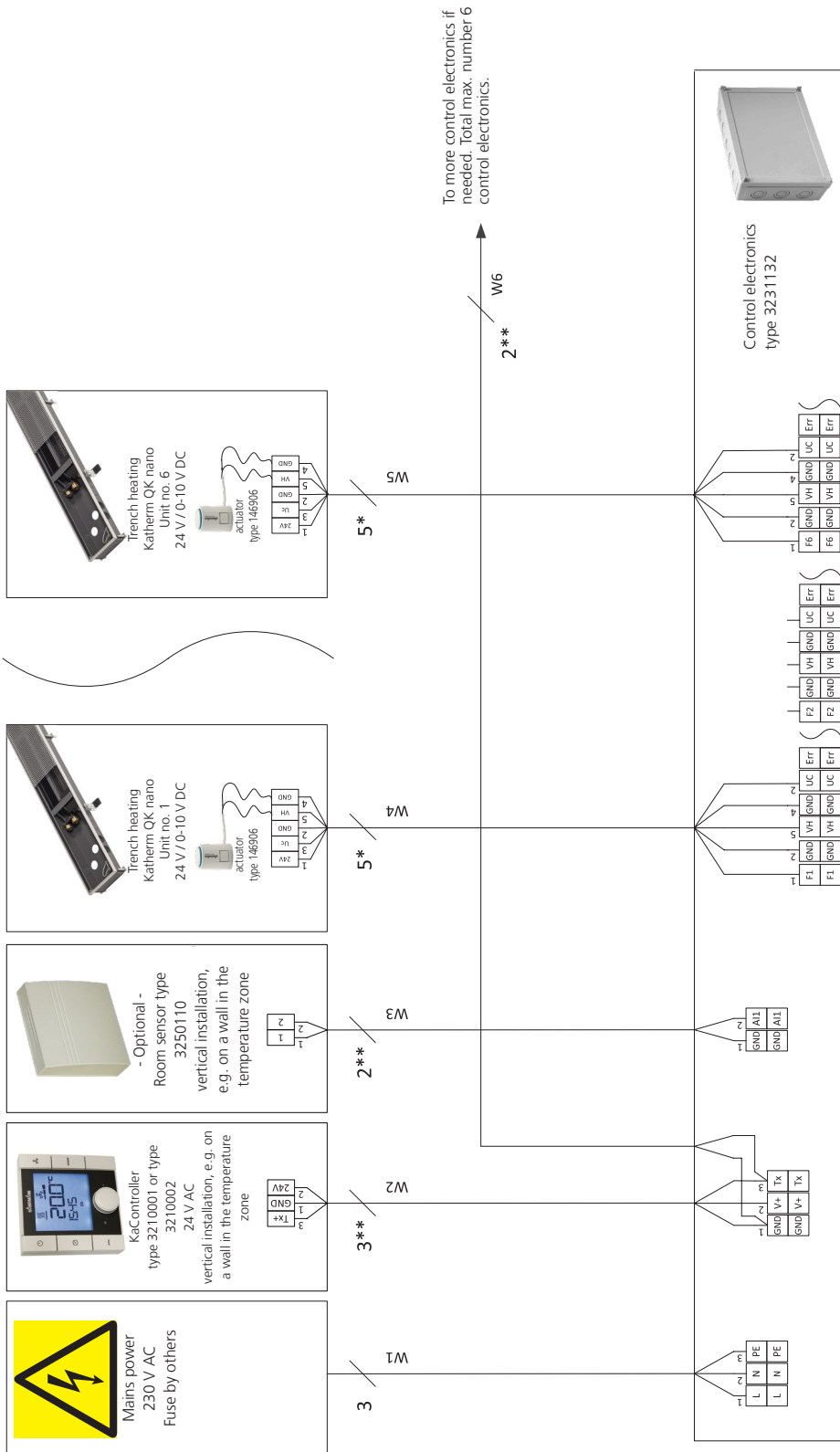

* Lay shielded cables (e.g. IY(ST)Y, 0.8 mm), separately from high-voltage cables.
 ** Lay shielded, paired cables, e.g. CAT5 (AWG23) of at least the same value, separately from high-voltage cables.
 W1: Power supply
 W2: Bus signal (tLan)
 W3: Analogue input AI1 (optional connection)
 W4: Control signal for fan and actuator, total maximum cable length 10 m
 W5: Control signal for fan and actuator, total maximum cable length 10 m
 W6: Bus signal (tLan)
 Subject to technical modifications: Refer to the control accessory documentation in the event of deviation from the circuit diagrams!

KaControl electrical cabling - BMS control

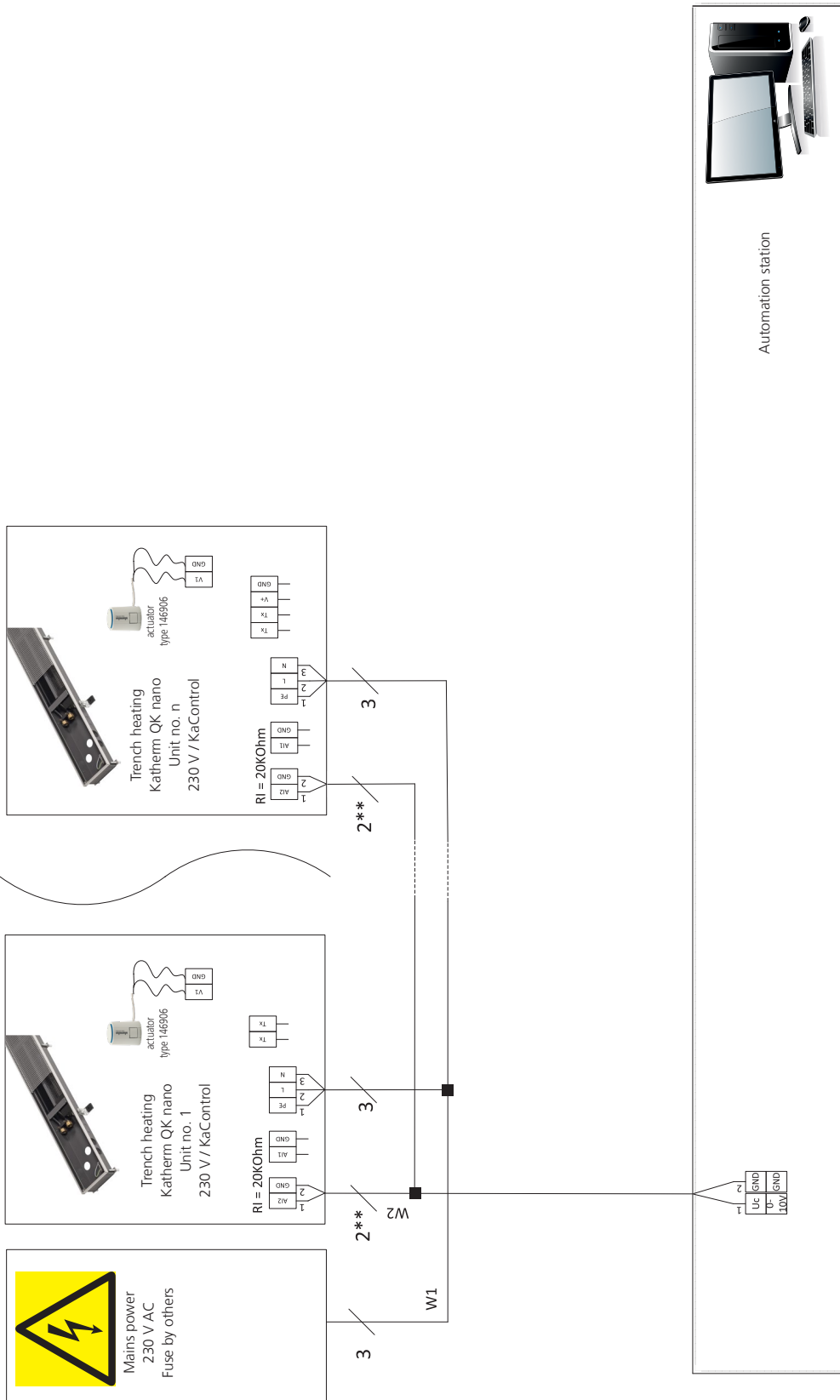

** Lay shielded, paired cables, e.g. CAT5 (AWG23) of at least the same value, separately from high-voltage cables.

W1: Power supply

W2: Control signal for fan and actuator.

Subject to technical modifications: Refer to the control accessory documentation in the event of deviation from the circuit diagrams!

05 ▶ Ordering information

Katherm QK nano

Trench height	Trench width	Trench length	Grille finish	Art. no.
[mm]	[mm]	[mm]		
24 V electromechanical control				
70	165	900	FineLine Q	44217072 23 1324
			FineLine L	44217074 23 1324
		1400	FineLine Q	44217072 23 2324
			FineLine L	44217074 23 2324
		1800	FineLine Q	44217072 23 3124
			FineLine L	44217074 23 3124
		2100	FineLine Q	44217072 23 3724
			FineLine L	44217074 23 3724
		2600	FineLine Q	44217072 23 4724
			FineLine L	44217074 23 4724
230 V electromechanical control				
70	165	1100	FineLine Q	44217072 23 1700
			FineLine L	44217074 23 1700
		1600	FineLine Q	44217072 23 2700
			FineLine L	44217074 23 2700
		2000	FineLine Q	44217072 23 3500
			FineLine L	44217074 23 3500
		2300	FineLine Q	44217072 23 4100
			FineLine L	44217074 23 4100
		2700	FineLine Q	44217072 23 4900
			FineLine L	44217074 23 4900
KaControl				
70	165	1100	FineLine Q	44217072 23 17C1
			FineLine L	44217074 23 17C1
		1600	FineLine Q	44217072 23 27C1
			FineLine L	44217074 23 27C1
		2000	FineLine Q	44217072 23 35C1
			FineLine L	44217074 23 35C1
		2300	FineLine Q	44217072 23 41C1
			FineLine L	44217074 23 41C1
		2700	FineLine Q	44217072 23 49C1
			FineLine L	44217074 23 49C1

As standard, Katherm QK nano are supplied with a FineLine Q-grille powder coated in RAL 9006 (white aluminium). This can be replaced by one of the following grilles at a surcharge. Please change the two red digits in the article number to select an alternative grille.

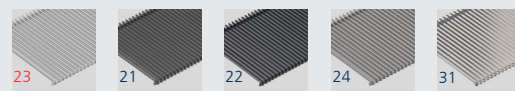

Article key for grille finish (example of art. no.)







0 →
4421707223**1324** → Steel, coated RAL 9006 (standard)
21 → Steel, coated DB 703
22 → Steel, coated RAL 9005
24 → Steel, coated RAL 9007
31 → Stainless steel, natural

The above grilles are shown using a four-colour printing process and thus do not represent an exact reproduction of the original colour.



Accessories

Figure	Article	Properties	Suitable for	Art. no.
Connecting accessories				
	Valve kit Valve body, 24 V actuator and return fitting	Valve body, axial, 1/2" connection, pre-settable, return shut-off valve, straight, 1/2" connection, 24 V thermoelectric actuator, connecting piece	all Katherm QK nano	194000442100
	Connection kit 2 return fittings	2 return shut-off valves, straight, 1/2" connection, connecting piece, for use on the Katherm QK nano with a central heating circuit distributor		194000442101
24 V electromechanical control accessories				
	Power unit for max. 3 Katherm QK nano	230 V AC/24 V: for max. 3 Katherm QK nano 24 V model, for external installation outside the trench convector	Katherm QK nano, electromechanical 24 V model	196901335152
	Power unit for max. 5 Katherm QK nano	230 V AC/24 V: for max. 5 Katherm QK nano 24 V model, for external installation outside the trench convector		196901338401
	Power unit for max. 7 Katherm QK nano	230 V AC/24 V: for max. 7 Katherm QK nano 24 V model, for external installation outside the trench convector		196901338402
230 V electromechanical control accessories				
	Room thermostat type 342924	Continuously variable speed controller combined with a thermostat for room temperature-dependent two-point control of Katherm QK nano units. The fan speed is set manually on the speed controller at between 0-100%. The thermostats activate the Katherm QK nano according to the temperature at the pre-set speed.	Katherm QK nano, 230 V electromechanical model	194000342924
24 V electromechanical control accessories				
	Clock thermostat type 30456	Clock thermostat 24 V, heating/cooling with 2-pipe system, flush-mounted, continuously variable, with LCD operating menu and integrated timer program, heating/cooling changeover by means of external potential-free contact (low voltage)	Katherm QK nano, 24 V electromechanical model	19600030456

Accessories

Figure	Article	Properties	Suitable for	Art. no.
KaControl accessories				
	KaController operating unit with one-touch operation	Operating unit, wall-mounted, in high-grade design, plastic housing, colour similar to RAL 9010, large LCD multifunctional display, integrated room temperature sensor, communication interface to Kampmann T-LAN bus system, automatically switching LED backlight, press/turn dial with click stop function, individually adjustable basic display, integrated day, night and week program, password-protected parameter level for C1 control option	Katherm QK nano, KaControl model	196003210001
	KaController operating unit with side function keys	For quick access to fan setting, operating modes, Eco mode, time and timer program, otherwise as art. no. 196003210001	Katherm QK nano, KaControl model	196003210002
	KaController operating unit with one-touch operation	Room control unit for wall mounting, high-quality design, plastic housing, colour similar to RAL 9017, otherwise as art. no. 169003210001	Katherm QK nano, KaControl model	196003210006
	Room temperature sensor	For wall mounting, IP30 surface-mounted, white RAL 9010, alternative to the temperature sensor in the KaController	Katherm QK nano, KaControl model	196003250110
	Serial CANBus card	For increasing the number of units in a single-circuit system to a maximum of 30 units, 1 x required per Katherm QK nano unit	Katherm QK nano, KaControl model	196003260301
	Serial Modbus card	For connection to Modbus networks	Katherm QK nano, KaControl model	196003260101
	Serial KNX card	For integration into KNX/EIB networks	Katherm QK nano, KaControl model	196003260701

[more »](#)

Figure	Article	Properties	Suitable for	Art. no.
	KaControl electronics	For the operation of max. 2 Katherm QK nano 24 V models, for external installation outside the trench heater	Katherm QK nano, 24 V model	196003231131
		For the operation of max. 6 Katherm QK nano 24 V models, for external installation outside the trench heater		196003231132
Other accessories				
	Installation cover	Made of wood to provide protection during installation, factory-fitted Grilles are supplied separately	All Katherm QK nano	194000101916

Katherm QK at a glance

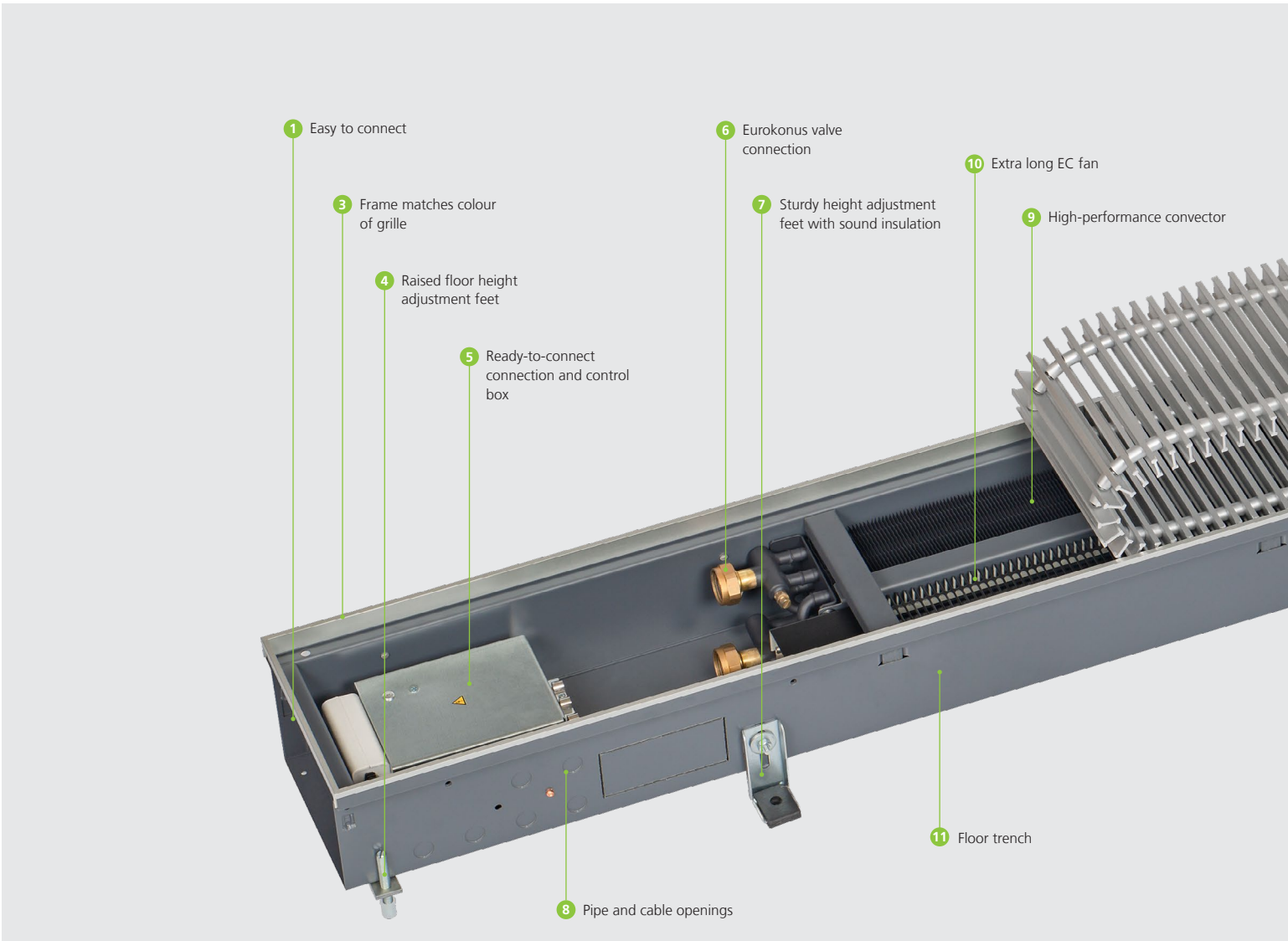

Features

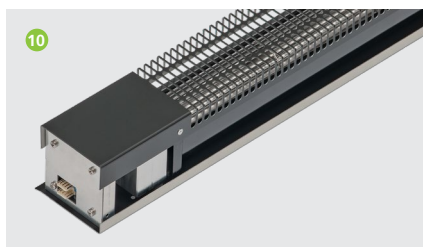
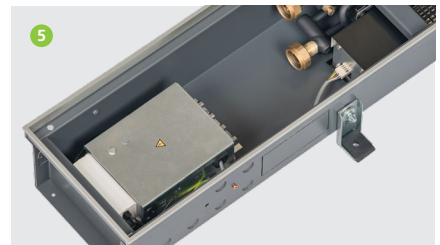

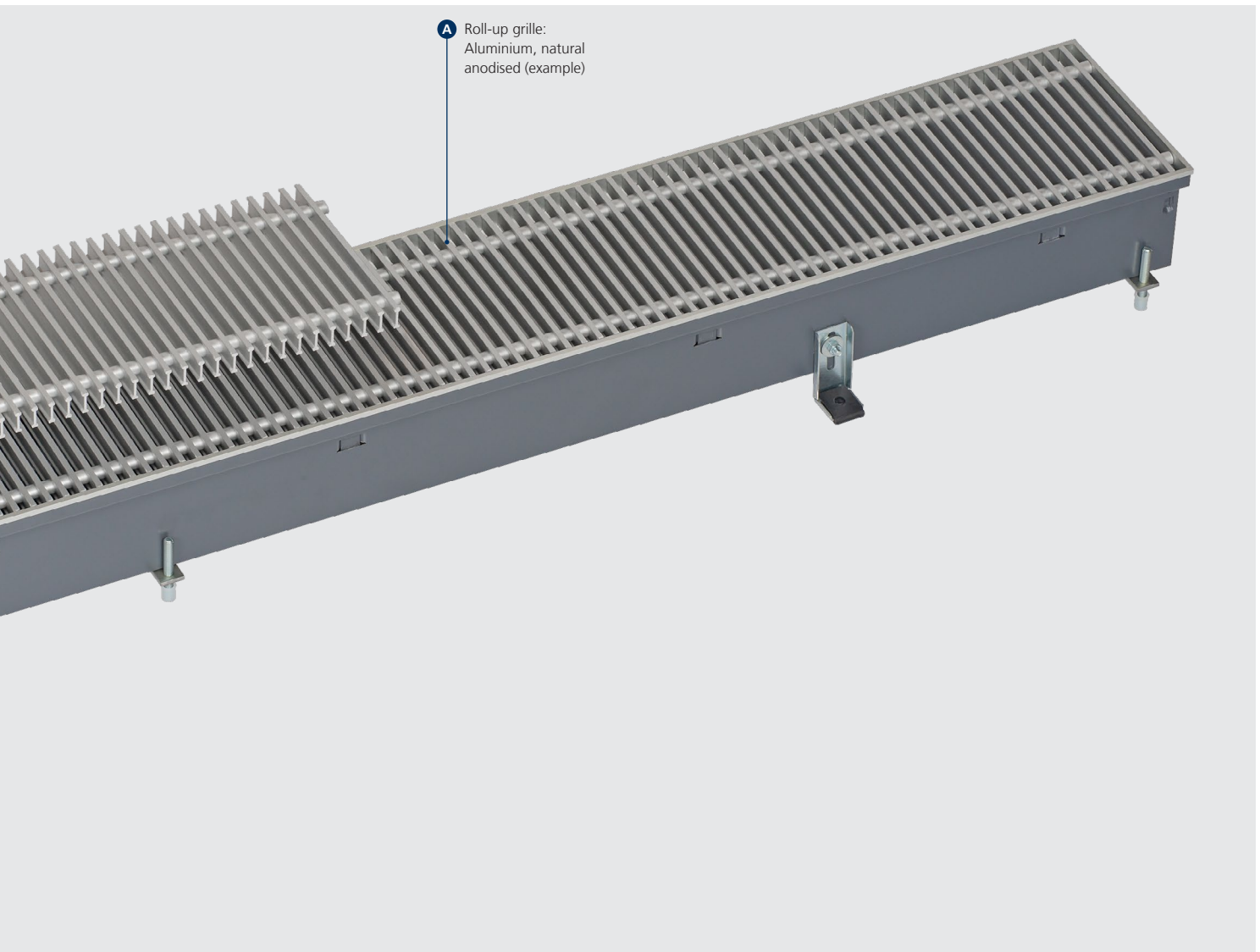

- 1 **Easy to connect**
 - ▶ removable end panel for ease of connection of trenches
- 2 **Cover plate**
 - ▶ as visual protection and to protect against dirt
- 3 **Frame matches colour of grille**
- 4 **Load-bearing height adjustment feet**
 - ▶ for the safe and standard mounting of the trench
- 5 **Ready-to-connect connection and control box**
 - ▶ for quick and safe electrical connection
 - ▶ saves installation time
 - ▶ for Ka-Control C1 and 230 V electromechanical -00 control options
 - ▶ including 230/24 V power unit
- 6 **Eurokonus valve connection**
 - ▶ for fast connection
 - ▶ saves installation time
- 7 **Sturdy height adjustment feet**
- 8 **Impact sound insulation**
 - ▶ for the simple fixing of the floor trench
 - ▶ prevents sound transmission
- 9 **Pipe and cable openings**
 - ▶ for water and electrical connections
 - ▶ punched
- 10 **High-performance convector:**
 - ▶ proven combination of copper/aluminium
 - ▶ optimised for air flow and heat dissipation
 - ▶ graphite-grey coated
- 11 **Extra-long EC fan**
 - ▶ for an even airflow through the convector, providing high heat outputs with low noise emissions
 - ▶ robust motor design
 - ▶ continuously variable speed control via an external 0 – 10 V signal
 - ▶ motor monitoring with internal fault processing
- 12 **Floor trench**
 - ▶ galvanised sheet steel
 - ▶ graphite-grey coated on both sides
 - ▶ with cross bracing to reinforce the floor trench
- 13 **Electrical wiring**
 - ▶ 24 V electromechanical model -24
- A **Aluminium roll-up grille, natural anodised**
 - ▶ double T-profile roll-up or linear grille
 - ▶ bar dimension 18 x 5 mm (stainless steel 18 x 6 mm)
 - ▶ bar spacing 12 mm, free area approx. 70% (aluminium anodised, brass)
 - ▶ bar spacing 10.5 mm, free area approx. 65% (stainless steel)
 - ▶ connections made of corrosion-proof steel springs with spacers in a matching colour
 - ▶ roll-up or linear grilles with 9 mm bar spacing, free area approx. 65% (aluminium, anodised, brass) optionally available

Matching grilles

Optiline roll-up grilles

Aluminium
Natural anodised

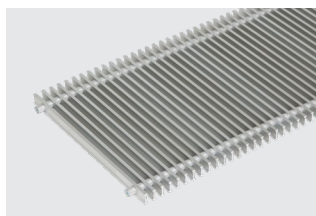

Aluminium
Brass anodised

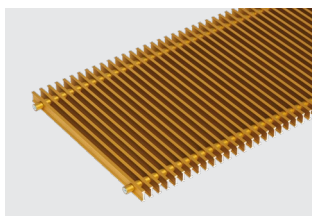

Aluminium
Bronze anodised



Aluminium
Black anodised

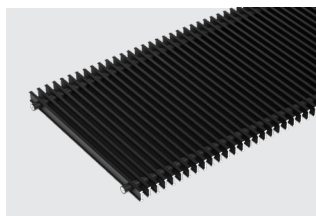

Aluminium
Light Bronze

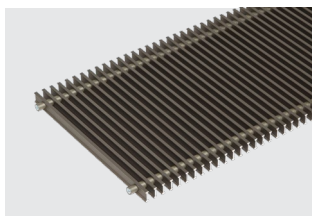

Aluminium
Coated DB 703

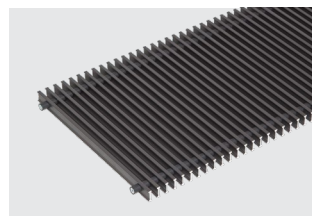

Stainless steel
Natural

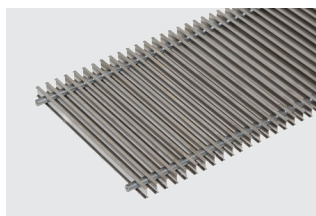

Stainless steel
Polished



Brass
Natural CuZn 44

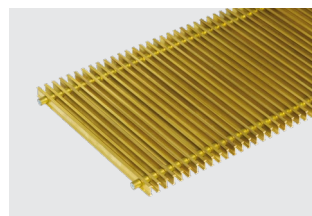

Linear grilles, Optiline

Aluminium
Natural anodised

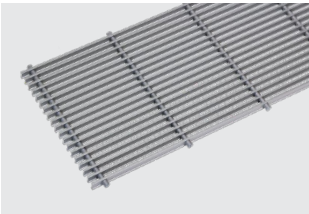

Aluminium
Brass anodised

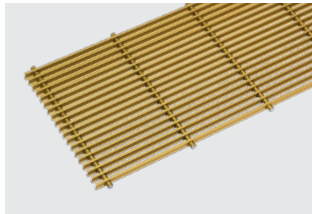

Aluminium
Bronze anodised

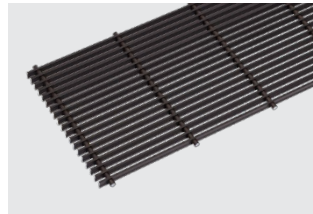

Aluminium
Light Bronze

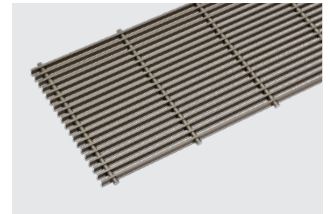

► For more grilles, please visit
Kampmann.co.uk/grilles

The above grilles are shown using a four-colour printing process and thus do not represent an exact reproduction of the original colour.

Optiline double-T profile dimensions

Optiline double-T profile	Figure	Bar spacing, free area
Aluminium, anodised brass		12 mm approx. 70%
Aluminium, anodised, brass		9 mm approx. 65 %
Stainless steel		10.5 mm approx. 65 %

02 ▶ Technical data

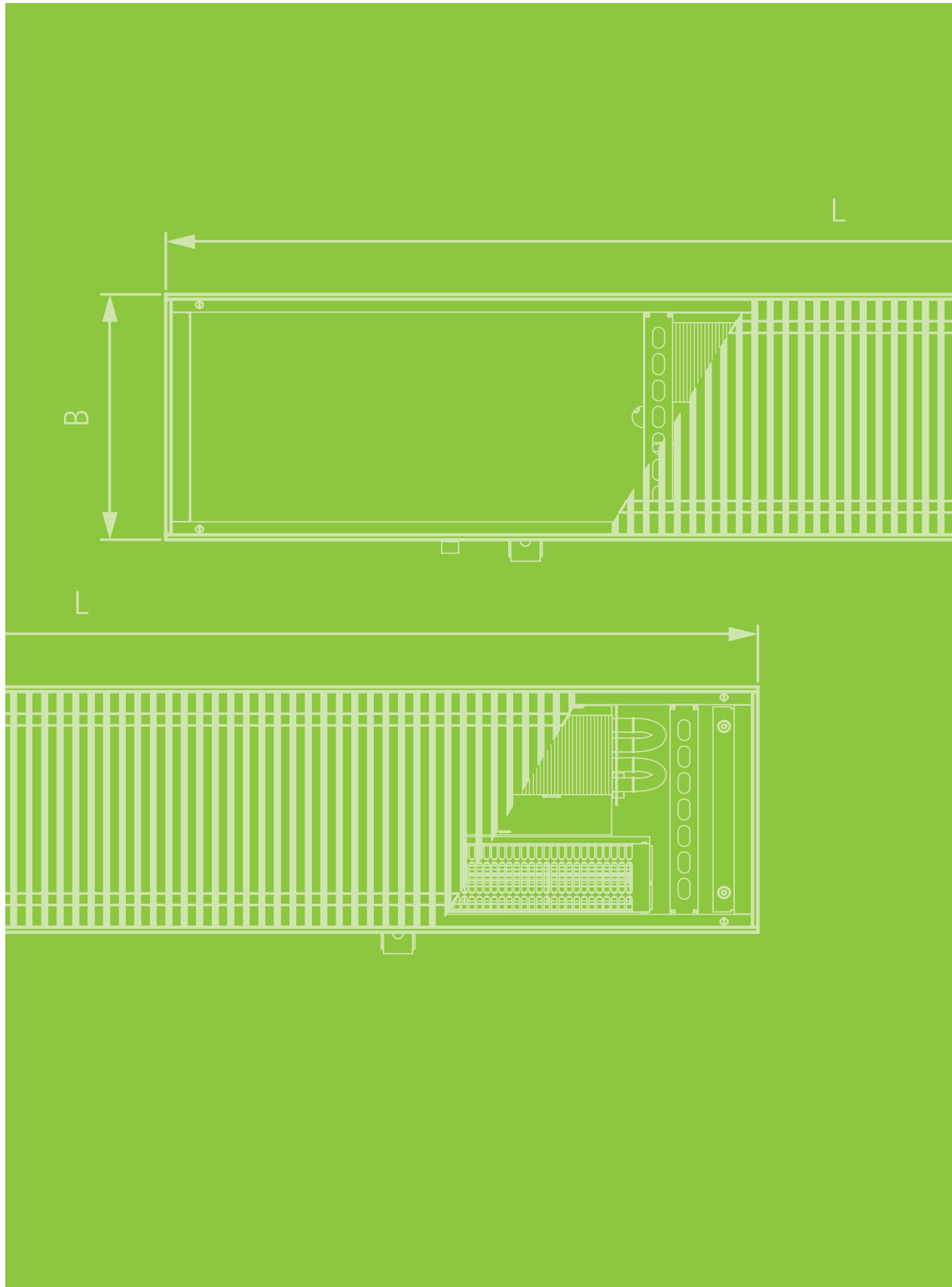

Advice on measuring conditions

Heat outputs

The heat outputs were measured and determined in accordance with DIN EN 16430 “Fan-assisted radiators, convectors and trench convectors”.

Part 1 “Technical specifications and requirements”
Part 2 “Test method and evaluation of heat output”

The specific requirements for trench heating are taken into account in DIN EN 16430. The reference/air temperature is measured in the centre of the test chamber (2 metres from the external wall) at a height of 0.75 metres. The surface temperature of the façade is 16°C. Experience has shown that the underfloor convector is positioned at a distance of 50 mm from the façade.

Acoustics

Katherm QK are very often used in acoustically sensitive areas. Accordingly, Katherm QK have been optimised in terms of noise levels. (Determination of the sound power and sound energy levels of sources of sound from sound pressure measurements – precision 2 class of enveloping measurement surface for an essentially free sound field over a reflective plane). The sound power level is measured according to DIN EN ISO 3744 in a semi-low reflective sound measuring chamber.



Acoustic measuring chamber

Katherm QK 190

Technical drawings (all dimensions in mm)

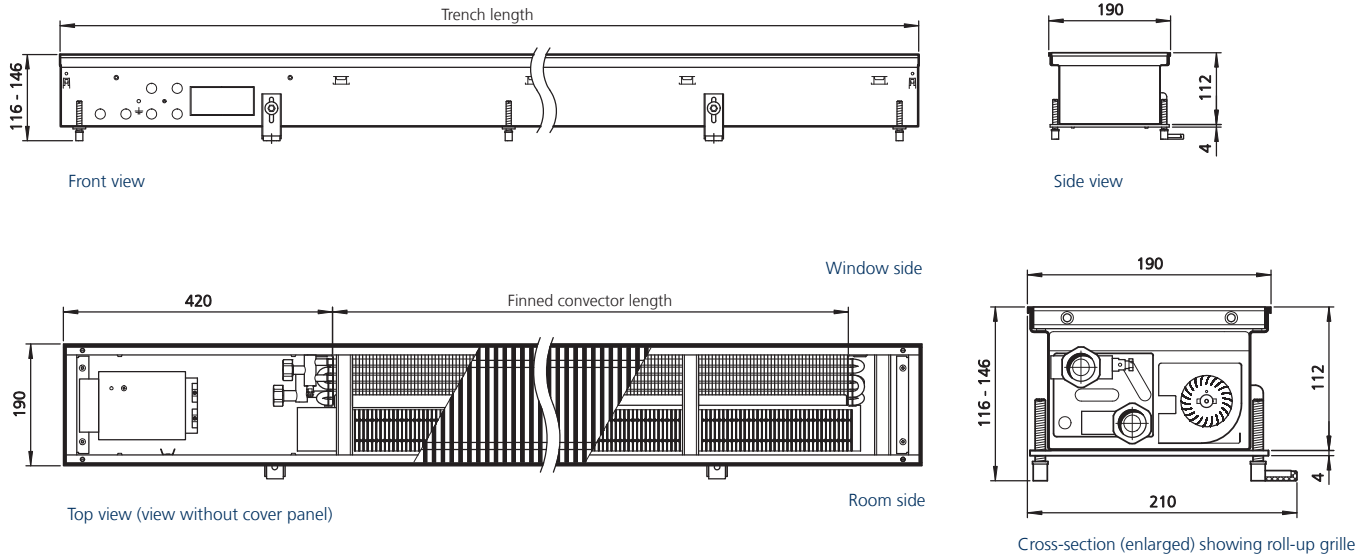

Trench length	Finned convector length
[mm]	[mm]
1000	430
1200	665
1400	865
1600	1100
1800	1300
2000	1300

Trench length	Finned convector length
[mm]	[mm]
2200	1640
2400	1840
2600	2075
2800	2275
3000	2510
3200	2710

Specifications

Connections, female thread:

Eurokonus, same end, connections on left

Make use of our online calculation programs to calculate your heat outputs and flow rates with a couple of clicks!

- ▶ Kampmann.co.uk/katherm-qk/calculation
- ▶ Kampmann.eu/katherm-qk/calculation

Water pressure drop: heating curve

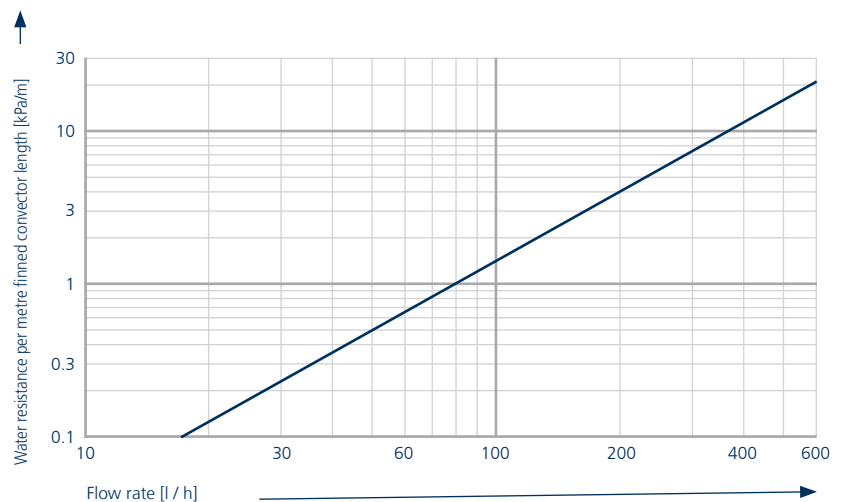

Outputs grill bar spacing 12 mm, free area approx. 70%⁵⁾



Fan stage	at speed setting	Heat outputs ¹⁾		Power consumption ^{2), 6)}	Current consumption ⁶⁾	Air volume	Sound pressure level ³⁾	Sound power level
		at LPHW 75 / 65 °C	at LPHW 82 / 71 °C					
	[%]	Q _N [W]	Q [W]	P [W]	I [mA]	[m ³ /h]	[dB(A)]	[dB(A)]
Trench length 1000 mm								
Boost stage	100	917	1041	6.3	76	91	26	34
Design levels	80	809	916	5.2	68	86	22	30
	60	688	777	4.5	61	70	< 20 ⁴⁾	< 28 ⁴⁾
	40	559	631	4.1	58	52	< 20 ⁴⁾	< 28 ⁴⁾
Minimum stage	20	437	496	3.6	54	43	< 20 ⁴⁾	< 28 ⁴⁾
Natural convection		71	84	---	---	---	---	---
Trench length 1200 mm								
Boost stage	100	1419	1609	7.7	86	137	29	37
Design levels	80	1252	1417	6.1	73	129	25	33
	60	1064	1202	5.2	67	105	21	29
	40	864	976	4.5	62	78	< 20 ⁴⁾	< 28 ⁴⁾
Minimum stage	20	676	768	3.8	56	65	< 20 ⁴⁾	< 28 ⁴⁾
Natural convection		109	130	---	---	---	---	---
Trench length 1400 mm								
Boost stage	100	1845	2093	9.2	97	183	31	39
Design levels	80	1628	1843	7.4	84	172	28	36
	60	1385	1564	6.0	72	139	23	31
	40	1124	1269	4.8	64	104	< 20 ⁴⁾	< 28 ⁴⁾
Minimum stage	20	879	998	4.2	58	87	< 20 ⁴⁾	< 28 ⁴⁾
Natural convection		142	169	---	---	---	---	---
Trench length 1600 mm								
Boost stage	100	2347	2662	10.9	114	228	33	41
Design levels	80	2070	2344	8.6	95	215	30	38
	60	1761	1988	6.7	79	174	25	33
	40	1429	1614	5.2	67	130	< 20 ⁴⁾	< 28 ⁴⁾
Minimum stage	20	1118	1270	4.4	60	108	< 20 ⁴⁾	< 28 ⁴⁾
Natural convection		181	215	---	---	---	---	---

Q_N [W] = Standard heat output
 Q [W] = Heat output

more »

1) At room temperature t_L = 20 °C
 2) Add an additional power consumption of 1 W per valve drive type 146906.
 3) The sound pressure levels were calculated with an assumed room insulation of 8 dB(A). This corresponds to a clearance of 2 m, a room volume of 100m³ and a reverberation time of 0.5 s (according to VDI 2081).
 4) Sound pressure level < 20 dB (A) and sound power level < 28 dB (A) outside the usual measuring and audible range.
 5) Heat outputs for bar spacing 9 mm (aluminium anodised, brass) and 10.5 mm (stainless steel); free area approx. 65% can be obtained from the calculation program.
 6) For power and current consumption for 24 V refer to the table showing control technology for 24 V electromechanical model.

Katherm QK 190

Outputs grille bar spacing 12 mm, free area approx. 70%⁵⁾



Fan stage	at speed setting	Heat outputs ¹⁾		Power consumption ^{2), 6)}	Current consumption ⁶⁾	Air volume	Sound pressure level ³⁾	Sound power level
		at LPHW 75 / 65 °C	at LPHW 82 / 71 °C					
	[%]	Q _N [W]	Q [W]	P [W]	I [mA]	[m ³ /h]	[dB(A)]	[dB(A)]
Trench length 1800 mm								
Boost stage	100	2773	3146	11.5	114	274	35	43
Design levels	80	2447	2770	8.7	95	258	31	39
	60	2081	2350	6.8	84	209	26	34
	40	1689	1908	5.4	74	156	21	29
Minimum stage	20	1322	1500	4.5	65	130	< 20 ⁴⁾	< 28 ⁴⁾
Natural convection		214	254	---	---	---	---	---
Trench length 2000 mm								
Boost stage	100	2773	3146	11.5	114	274	35	43
Design levels	80	2447	2770	8.7	95	258	31	39
	60	2081	2350	6.8	84	209	26	34
	40	1689	1908	5.4	74	156	21	29
Minimum stage	20	1322	1500	4.5	65	130	< 20 ⁴⁾	< 28 ⁴⁾
Natural convection		214	254	---	---	---	---	---
Trench length 2200 mm								
Boost stage	100	3498	3969	12.1	114	320	36	44
Design levels	80	3087	3494	8.8	96	301	32	40
	60	2625	2964	7.8	84	244	28	36
	40	2131	2407	7.0	75	182	22	30
Minimum stage	20	1667	1893	6.1	68	152	< 20 ⁴⁾	< 28 ⁴⁾
Natural convection		269	321	---	---	---	---	---
Trench length 2400 mm								
Boost stage	100	3925	4453	13.6	117	365	37	45
Design levels	80	3463	3920	10.5	97	344	33	41
	60	2945	3326	8.3	85	279	29	37
	40	2391	2700	7.3	75	208	23	31
Minimum stage	20	1871	2124	6.3	68	173	< 20 ⁴⁾	< 28 ⁴⁾
Natural convection		302	360	---	---	---	---	---

Q_N [W] = Standard heat output

Q [W] = Heat output

more »

¹⁾ At room temperature t_l = 20 °C

²⁾ Add an additional power consumption of 1 W per valve drive type 146906.

³⁾ The sound pressure levels were calculated with an assumed room insulation of 8 dB(A). This corresponds to a clearance of 2 m, a room volume of 100 m³ and a reverberation time of 0.5 s (according to VDI 2081).

⁴⁾ Sound pressure level < 20 dB (A) and sound power level < 28 dB (A) outside the usual measuring and audible range.

⁵⁾ Heat outputs for bar spacing 9 mm (aluminium anodised, brass) and 10.5 mm (stainless steel); free area approx. 65% can be obtained from the calculation program.

⁶⁾ For power and current consumption for 24 V refer to the table showing control technology for 24 V electromechanical model.

Outputs grille bar spacing 12 mm, free area approx. 70%⁵⁾



Fan stage	at speed setting	Heat outputs ¹⁾		Power consumption ^{2), 6)}	Current consumption ⁶⁾	Air volume	Sound pressure level ³⁾	Sound power level
		at LPHW 75 / 65 °C	at LPHW 82 / 71 °C					
	[%]	Q _N [W]	Q [W]	P [W]	I [mA]	[m ³ /h]	[dB(A)]	[dB(A)]
Trench length 2600 mm								
Boost stage	100	4426	5021	15.0	128	411	37	45
Design levels	80	3906	4421	11.3	102	387	34	42
	60	3321	3751	8.8	86	314	30	38
	40	2696	3045	7.5	76	234	24	32
Minimum stage	20	2109	2395	6.5	71	195	20	28
Natural convection		341	406	---	---	---	---	---
Trench length 2800 mm								
Boost stage	100	4853	5505	17.4	146	457	39	47
Design levels	80	4282	4847	12.9	116	430	35	43
	60	3641	4112	9.9	95	348	31	39
	40	2956	3339	7.7	79	260	25	33
Minimum stage	20	2313	2626	6.6	73	217	21	29
Natural convection		374	445	---	---	---	---	---
Trench length 3000 mm								
Boost stage	100	5354	6074	19.4	159	502	40	48
Design levels	80	4725	5348	13.8	121	473	36	44
	60	4018	4537	10.5	97	383	32	40
	40	3261	3684	8.0	81	286	26	34
Minimum stage	20	2552	2897	6.7	73	238	22	30
Natural convection		412	491	---	---	---	---	---
Trench length 3200 mm								
Boost stage	100	5781	6558	21.1	173	548	41	49
Design levels	80	5101	5774	14.6	128	516	37	45
	60	4338	4898	10.8	101	418	32	40
	40	3521	3977	8.2	83	312	27	35
Minimum stage	20	2755	3128	6.8	74	260	22	30
Natural convection		445	530	---	---	---	---	---

Q_N [W] = Standard heat output
 Q [W] = Heat output

1) At room temperature t_L = 20 °C
 2) Add an additional power consumption of 1 W per valve drive type 146906.
 3) The sound pressure levels were calculated with an assumed room insulation of 8 dB(A). This corresponds to a clearance of 2 m, a room volume of 100 m³ and a reverberation time of 0.5 s (according to VDI 2081).
 4) Sound pressure level < 20 dB (A) and sound power level < 28 dB (A) outside the usual measuring and audible range.
 5) Heat outputs for bar spacing 9 mm (aluminium anodised, brass) and 10.5 mm (stainless steel); free area approx. 65% can be obtained from the calculation program.
 6) For power and current consumption for 24 V refer to the table showing control technology for 24 V electromechanical model.

Katherm QK 215

Technical drawings (all dimensions in mm)

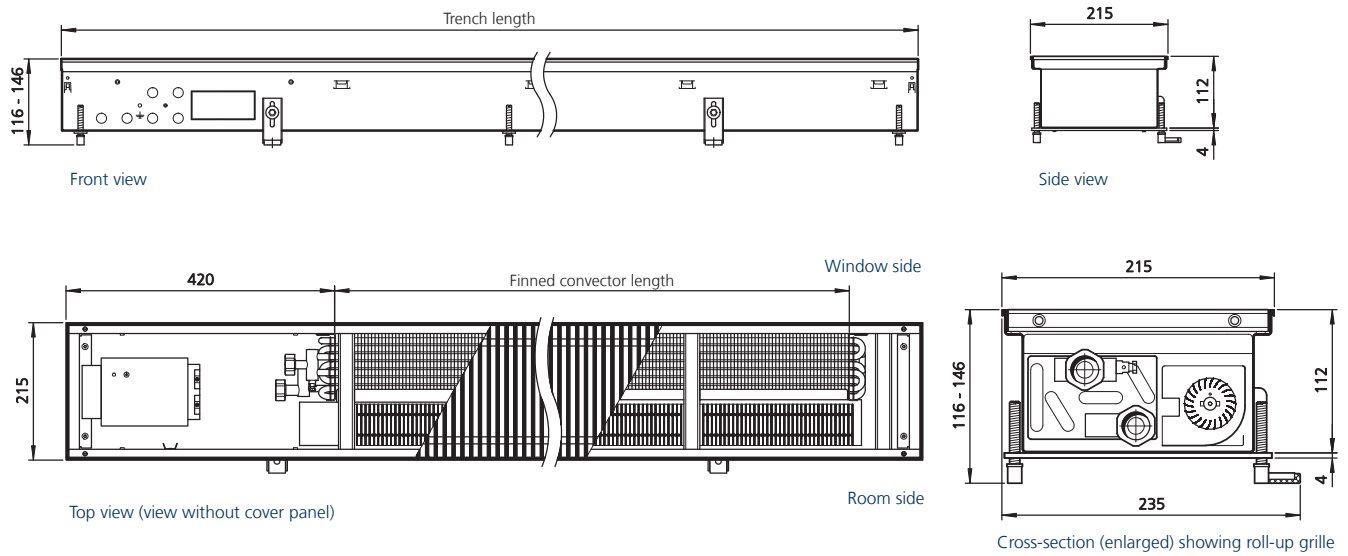

Trench length	Finned convector length
[mm]	[mm]
1000	430
1200	665
1400	865
1600	1100
1800	1300
2000	1300

Trench length	Finned convector length
[mm]	[mm]
2200	1640
2400	1840
2600	2075
2800	2275
3000	2510
3200	2710

Specifications

Connections, female thread:

Eurokonus, same end, connections on left

Make use of our online calculation programs to calculate your heat outputs and flow rates with a couple of clicks!

- ▶ Kampmann.co.uk/katherm-qk/calculation
- ▶ Kampmann.eu/katherm-qk/calculation

Water pressure drop: heating curve

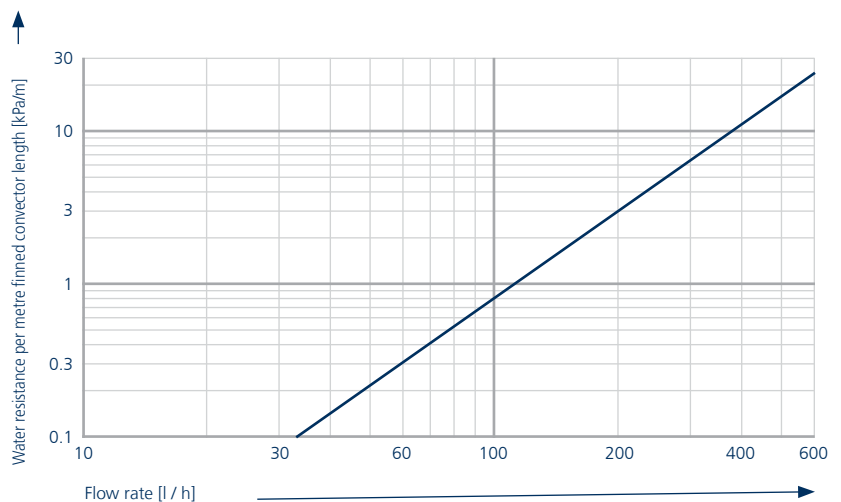

Outputs grille bar spacing 12 mm, free area approx. 70%⁵⁾



Fan stage	at speed setting	Heat outputs ¹⁾		Power consumption ^{2), 6)}	Current consumption ⁶⁾	Air volume	Sound pressure level ³⁾	Sound power level
		at LPHW 75 / 65 °C	at LPHW 82 / 71 °C					
	[%]	Q _N [W]	Q [W]	P [W]	I [mA]	[m ³ /h]	[dB(A)]	[dB(A)]
Trench length 1000 mm								
Boost stage	100	956	1090	6.3	76	91	26	34
Design levels	80	874	993	5.2	68	86	22	30
	60	786	893	4.5	61	70	< 20 ⁴⁾	< 28 ⁴⁾
	40	666	753	4.1	58	52	< 20 ⁴⁾	< 28 ⁴⁾
Minimum stage	20	522	589	3.6	54	43	< 20 ⁴⁾	< 28 ⁴⁾
Natural convection		87	105	---	---	---	---	---
Trench length 1200 mm								
Boost stage	100	1478	1686	7.7	86	137	29	37
Design levels	80	1352	1536	6.1	73	129	25	33
	60	1215	1382	5.2	67	105	21	29
	40	1030	1165	4.5	62	78	< 20 ⁴⁾	< 28 ⁴⁾
Minimum stage	20	807	911	3.8	56	65	< 20 ⁴⁾	< 28 ⁴⁾
Natural convection		134	162	---	---	---	---	---
Trench length 1400 mm								
Boost stage	100	1923	2193	9.2	97	183	31	39
Design levels	80	1758	1997	7.4	84	172	28	36
	60	1581	1797	6.0	72	139	23	31
	40	1340	1516	4.8	64	104	< 20 ⁴⁾	< 28 ⁴⁾
Minimum stage	20	1050	1185	4.2	58	87	< 20 ⁴⁾	< 28 ⁴⁾
Natural convection		175	211	---	---	---	---	---
Trench length 1600 mm								
Boost stage	100	2445	2789	10.9	114	228	33	41
Design levels	80	2236	2540	8.6	95	215	30	38
	60	2010	2285	6.7	79	174	25	33
	40	1704	1927	5.2	67	130	< 20 ⁴⁾	< 28 ⁴⁾
Minimum stage	20	1335	1507	4.4	60	108	< 20 ⁴⁾	< 28 ⁴⁾
Natural convection		222	268	---	---	---	---	---

Q_N [W] = Standard heat output
 Q [W] = Heat output

more »

1) At room temperature t_L = 20 °C
 2) Add an additional power consumption of 1 W per valve drive type 146906.
 3) The sound pressure levels were calculated with an assumed room insulation of 8 dB(A). This corresponds to a clearance of 2 m, a room volume of 100 m³ and a reverberation time of 0.5 s (according to VDI 2081).
 4) Sound pressure level < 20 dB (A) and sound power level < 28 dB (A) outside the usual measuring and audible range.
 5) Heat outputs for bar spacing 9 mm (aluminium anodised, brass) and 10.5 mm (stainless steel); free area approx. 65% can be obtained from the calculation program.
 6) For power and current consumption for 24 V refer to the table showing control technology for 24 V electromechanical model.

Katherm QK 215

Outputs grille bar spacing 12 mm, free area approx. 70%⁵⁾



Fan stage	at speed setting	Heat outputs ¹⁾		Power consumption ^{2), 6)}	Current consumption ⁶⁾	Air volume	Sound pressure level ³⁾	Sound power level
		at LPHW 75 / 65 °C	at LPHW 82 / 71 °C					
	[%]	Q _N [W]	Q [W]	P [W]	I [mA]	[m ³ /h]	[dB(A)]	[dB(A)]
Trench length 1800 mm								
Boost stage	100	2890	3296	11.5	114	274	35	43
Design levels	80	2642	3002	8.7	95	258	31	39
	60	2376	2701	6.8	84	209	26	34
	40	2014	2278	5.4	74	156	21	29
Minimum stage	20	1578	1780	4.5	65	130	< 20 ⁴⁾	< 28 ⁴⁾
Natural convection		262	316	---	---	---	---	---
Trench length 2000 mm								
Boost stage	100	2890	3296	11.5	114	274	35	43
Design levels	80	2642	3002	8.7	95	258	31	39
	60	2376	2701	6.8	84	209	26	34
	40	2014	2278	5.4	74	156	21	29
Minimum stage	20	1578	1780	4.5	65	130	< 20 ⁴⁾	< 28 ⁴⁾
Natural convection		262	316	---	---	---	---	---
Trench length 2200 mm								
Boost stage	100	3646	4157	12.1	114	320	36	44
Design levels	80	3333	3787	8.8	96	301	32	40
	60	2997	3407	7.8	84	244	28	36
	40	2541	2873	7.0	75	182	22	30
Minimum stage	20	1991	2246	6.1	68	152	< 20 ⁴⁾	< 28 ⁴⁾
Natural convection		331	399	---	---	---	---	---
Trench length 2400 mm								
Boost stage	100	4091	4664	13.6	117	365	37	45
Design levels	80	3740	4249	10.5	97	344	33	41
	60	3362	3823	8.3	85	279	29	37
	40	2851	3224	7.3	75	208	23	31
Minimum stage	20	2233	2520	6.3	68	173	< 20 ⁴⁾	< 28 ⁴⁾
Natural convection		371	448	---	---	---	---	---

Q_N [W] = Standard heat output
Q [W] = Heat output

more »

¹⁾ At room temperature t_l = 20 °C

²⁾ Add an additional power consumption of 1 W per valve drive type 146906.

³⁾ The sound pressure levels were calculated with an assumed room insulation of 8 dB(A). This corresponds to a clearance of 2 m, a room volume of 100 m³ and a reverberation time of 0.5 s (according to VDI 2081).

⁴⁾ Sound pressure level < 20 dB (A) and sound power level < 28 dB (A) outside the usual measuring and audible range.

⁵⁾ Heat outputs for bar spacing 9 mm (aluminium anodised, brass) and 10.5 mm (stainless steel); free area approx. 65% can be obtained from the calculation program.

⁶⁾ For power and current consumption for 24 V refer to the table showing control technology for 24 V electromechanical model.

Outputs grille bar spacing 12 mm, free area approx. 70%⁵⁾

Fan stage	at speed setting	Heat outputs ¹⁾		Power consumption ^{2), 6)}	Current consumption ⁶⁾	Air volume	Sound pressure level ³⁾	Sound power level
		at LPHW 75 / 65 °C	at LPHW 82 / 71 °C					
	[%]	Q _N [W]	Q [W]	P [W]	I [mA]	[m ³ /h]	[dB(A)]	[dB(A)]
Trench length 2600 mm								
Boost stage	100	4613	5260	15.0	128	411	37	45
Design levels	80	4217	4792	11.3	102	387	34	42
	60	3792	4311	8.8	86	314	30	38
	40	3215	3636	7.5	76	234	24	32
Minimum stage	20	2519	2842	6.5	71	195	20	28
Natural convection		419	505	---	---	---	---	---
Trench length 2800 mm								
Boost stage	100	5058	5767	17.4	146	457	39	47
Design levels	80	4624	5253	12.9	116	430	35	43
	60	4157	4727	9.9	95	348	31	39
	40	3525	3986	7.7	79	260	25	33
Minimum stage	20	2761	3116	6.6	73	217	21	29
Natural convection		459	554	---	---	---	---	---
Trench length 3000 mm								
Boost stage	100	5580	6363	19.4	159	502	40	48
Design levels	80	5101	5796	13.8	121	473	36	44
	60	4587	5215	10.5	97	383	32	40
	40	3889	4398	8.0	81	286	26	34
Minimum stage	20	3047	3438	6.7	73	238	22	30
Natural convection		506	611	---	---	---	---	---
Trench length 3200 mm								
Boost stage	100	6025	6870	21.1	173	548	41	49
Design levels	80	5508	6258	14.6	128	516	37	45
	60	4952	5630	10.8	101	418	32	40
	40	4199	4748	8.2	83	312	27	35
Minimum stage	20	3289	3712	6.8	74	260	22	30
Natural convection		547	660	---	---	---	---	---

Q_N [W] = Standard heat output

Q [W] = Heat output

¹⁾ At room temperature t_L = 20 °C

²⁾ Add an additional power consumption of 1 W per valve drive type 146906.

³⁾ The sound pressure levels were calculated with an assumed room insulation of 8 dB(A). This corresponds to a clearance of 2 m, a room volume of 100 m³ and a reverberation time of 0.5 s (according to VDI 2081).

⁴⁾ Sound pressure level < 20 dB (A) and sound power level < 28 dB (A) outside the usual measuring and audible range.

⁵⁾ Heat outputs for bar spacing 9 mm (aluminium anodised, brass) and 10.5 mm (stainless steel); free area approx. 65% can be obtained from the calculation program.

⁶⁾ For power and current consumption for 24 V refer to the table showing control technology for 24 V electromechanical model.

03 ▶ Design information



Information on planning and design

Katherm QK are suitable for use in all kinds of buildings demanding heating due to their internal loads.

High heating loads in the rooms can be met with ultra-quiet EC fans. Katherm QK are also used to efficiently combat condensation on external glazing.

They are generally positioned directly in front of the external façade without a large gap. Katherm QK can provide cost-effective and efficient heating, particularly in front of large areas of glazing.

Air outlet

All Katherm QK are positioned with the convector on the window side. The warm air rising up the exterior façade flows draught-free into the room, guaranteeing optimum cold air screening.

Acoustics

The respective sound power levels of Katherm QK are indicated in the tables (see "Technical Data"). The sound pressure levels were calculated with an assumed

room insulation of 8 dB(A). This corresponds to a distance of 2 m, a room volume of 100m³ and a reverberation time of 0.5 s (in accordance with VDI 2081).

As the sound level is not only due to the Katherm QK, but is also influenced by the number of Katherm QK and also very significantly by the acoustic characteristics of the room, the actual figure may vary in practice.

We would recommend designing Katherm QK taking into account the respective permitted sound pressure level in the room.

Heat outputs

The heat outputs were calculated based on DIN EN 16430. We would recommend our online calculation programs to convert to other operating conditions at:

Kampmann.de/katherm-qk/calculation

Make use of our online calculation programs to calculate your heat outputs and flow rates with a couple of clicks!

- ▶ Kampmann.co.uk/katherm-qk/calculation
- ▶ Kampmann.eu/katherm-qk/calculation

Katherm QK – supply air modules ZL

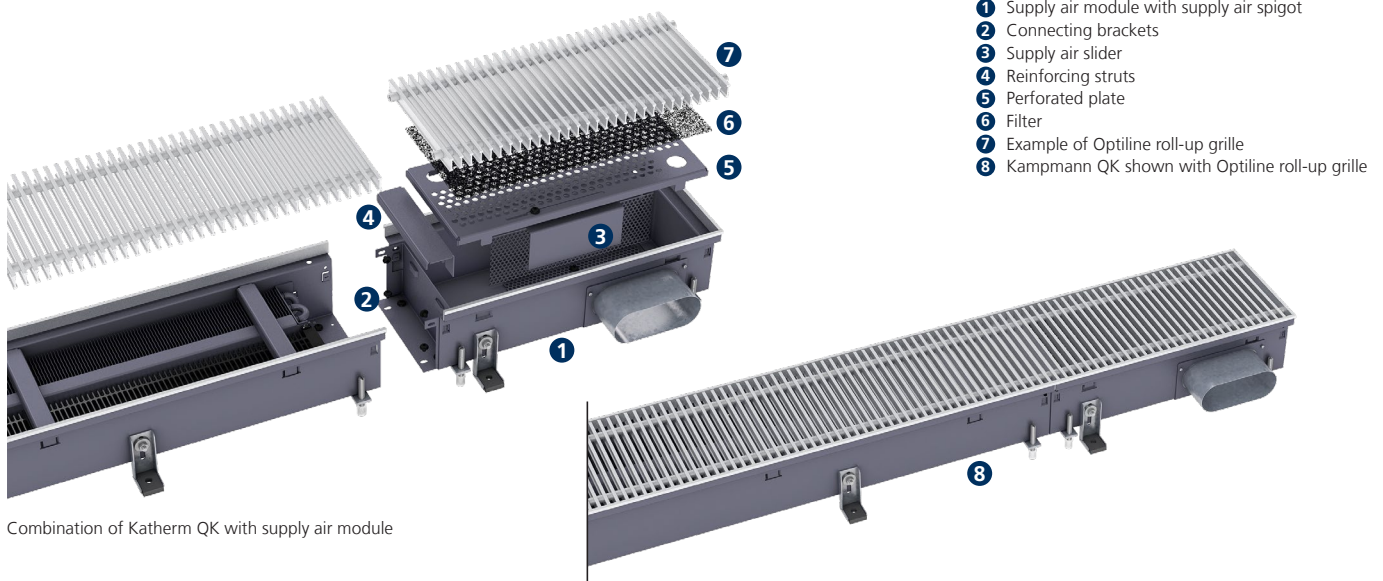

Combination of Katherm QK with supply air module

The Katherm supply air module ZL is available for all trench convectors (Katherm range). This represents a 400 mm long trench, which can be fitted to all designs of Katherm units. Treated supply air can also be fed into rooms through the Katherm supply air module ZL. This is achieved with different sizes/designs of spigots for the most diverse trench dimensions. It is possible to regulate the volumetric flow by means of slider elements in the supply air modules.

Benefits:

- ▶ available for trench widths and heights as per the table in the Katherm range
- ▶ supply air feed through the Katherm floor trench
- ▶ low leaving air speeds, hence pleasant levels of comfort
- ▶ low sound development when correctly designed
- ▶ low investment and maintenance costs
- ▶ supply air outlets visually identical to Katherm trench heaters
- ▶ no wear parts / no electrically rotating parts

Trench width	Trench length	Trench height	Supply air spigot	Design air volume
[mm]	[mm]	[mm]	[mm]	[m³/h]
190	400	112	oval 51x128	70
215	400	112	oval 51x128	70

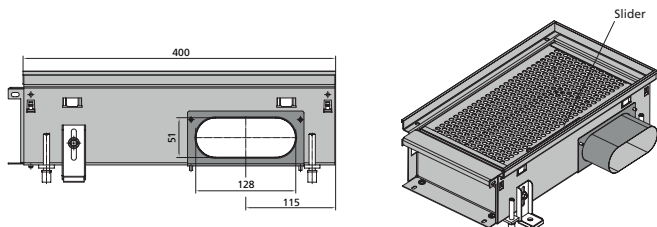

Example of 190/112

Comfort

Comfort also plays a key role in air conditioning. We'll help you to consider this aspect when designing a project using Kampmann trench convectors, at the same time as complying with the current guidelines in DIN EN 15251 (in future DIN EN 16798 Parts 1 and 2) and DIN EN ISO 7730. Essentially the following recommended values can be assumed:

For heating:
 **Supply air outlet air temperature:** 20–26 °C (but not lower than the room temperature)
 Outlet speed: < 1.5 m/s
 Distance of supply air trench to the occupied zone: > 0.5 m

For cooling:
 **Supply air outlet air temperature:** < 4K below room temperature
 Outlet speed: < 1.2 m/s
 Distance of supply air trench to the occupied zone: > 1 m

Other parameters

In individual cases, additional parameters, such as room and supply air humidity, as well as leaving air speed, need to be taken into consideration. (See DIN EN ISO 7730)

Additional information

The supply air models Katherm ZL can be used for cooling, heating or isothermic air exchange using preconditioned primary air. A spigot or connection at the front end is also possible with appropriate trench dimensions and sufficient space in the air outlet area (examination on request!).

The upper limit of the air volume in the spigot is calculated from the maximum air speed and cross-section of the spigot. This speed should not exceed 3.0 m/s to avoid additional sound emissions. The resulting air-side pressure losses vary according to the air volume as per the diagram.

Design diagram

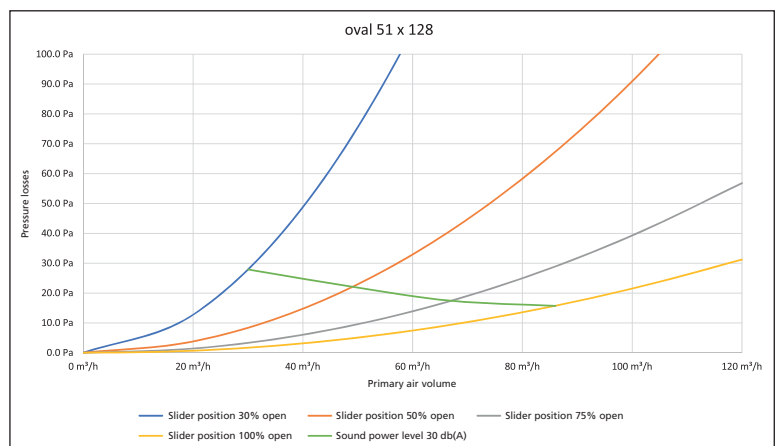

Hydraulic set-up

The Katherm QK (24 V electromechanical, 230 V electromechanical or KaControl) offers two hydraulic design options with the optional accessory kits. Valve kit type 142110 can be used if valve control is planned in the trench heater. If the hydraulic system is to be

controlled via a central heating circuit distributor, 2 no. return shut-off valves type 145952 can be used to shut off the copper-aluminium convectors.

Decentralised valve control

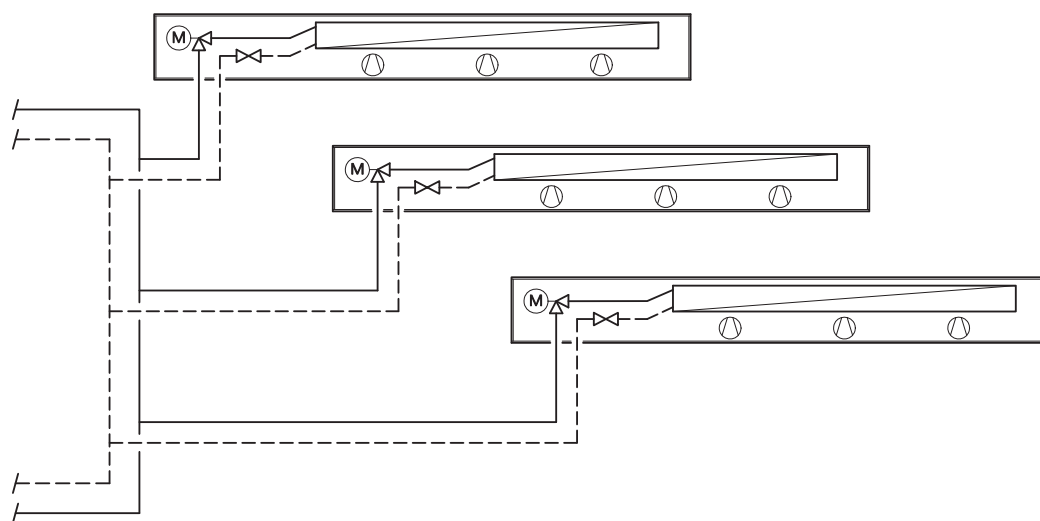

Accessories: Valve kit type 194000142110 or valve body type 194000346909, return shut-off valve type 194000145952, thermoelectric actuator type 194000146906 need to be ordered separately.

Central heating circuit distributor

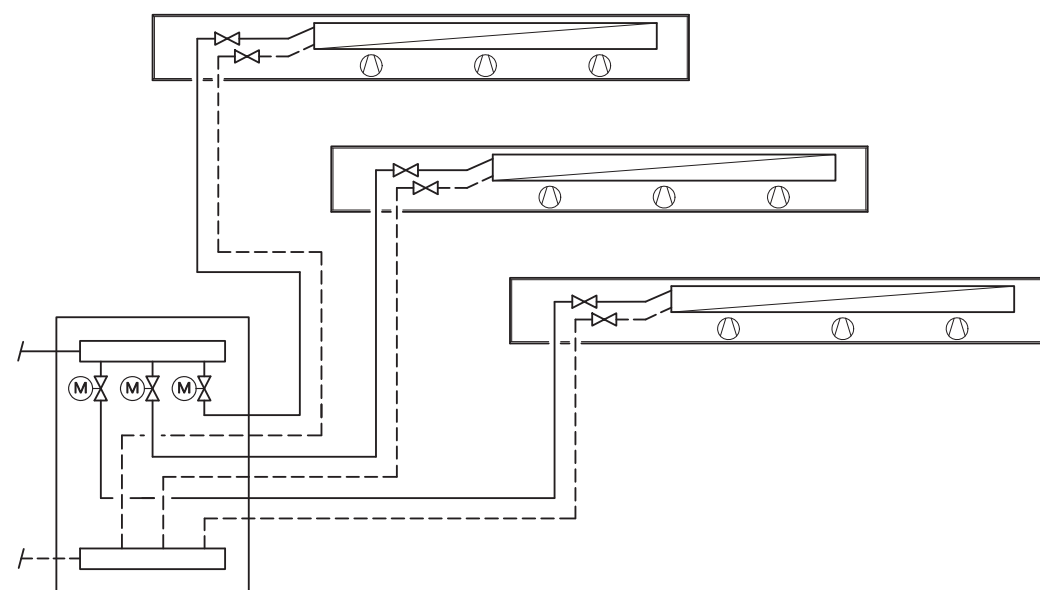

Accessories: 2 no. return shut-off valves type 194000145952 must be ordered separately.

04 ▶ Controls

Three different control options are available for ease of integration into individual control schemes. The 24 V version permits direct connection to on-site building management systems. An electromechanical control option using a room thermostat or alternatively the KaControl system are both available for continuously variable control with 230 V supply voltage. KaControl

represents the system solution for maximum energy efficiency, limitless integration options into building automation systems and the highest degree of user-friendly operating philosophy.

24 V electromechanical model

Model for complete on site control of the Katherm QK.

Product features

- ▶ The operating voltage must be provided by a central on-site 24 V DC voltage supply.
- ▶ The external voltage supply results in a space-saving connection area within the trench.
- ▶ Kampmann offers a range of switching power units in different output classes as accessories for the voltage supply (24 V DC).
- ▶ The fan automatically switches off in the event of a motor fault.

Table with rating values

Trench length [mm]	QK 190 / QK 215 Power consumption P [W] Current consumption I [mA] at fan speed									
	20%		40%		60%		80%		100%	
	P [W]	I [mA]	P [W]	I [mA]	P [W]	I [mA]	P [W]	I [mA]	P [W]	I [mA]
1000	2.6	39	3.1	44	3.5	47	4.2	55	5.3	64
1200	2.8	41	3.5	48	4.2	54	5.1	61	6.7	75
1400	3.2	44	3.8	51	5.0	60	6.4	73	8.2	86
1600	3.4	46	4.2	54	5.7	67	7.6	84	9.9	104
1800	3.5	51	4.4	59	5.8	70	7.7	85	10.5	104
2000	3.5	51	4.4	59	5.8	70	7.7	85	10.5	104
2200	5.1	57	6.0	64	6.8	71	7.8	86	11.1	105
2400	5.3	57	6.3	65	7.3	72	9.5	88	12.6	108
2600	5.5	60	6.5	66	7.8	76	10.3	93	14.0	119
2800	5.6	62	6.7	69	8.9	85	11.9	107	16.4	138
3000	5.7	62	7.0	71	9.5	88	12.8	112	18.4	151
3200	5.8	63	7.2	73	9.8	92	13.6	119	20.1	165

The power and current consumption of the actuators (1 W) is not taken into account.

Electrical cabling – BMS control

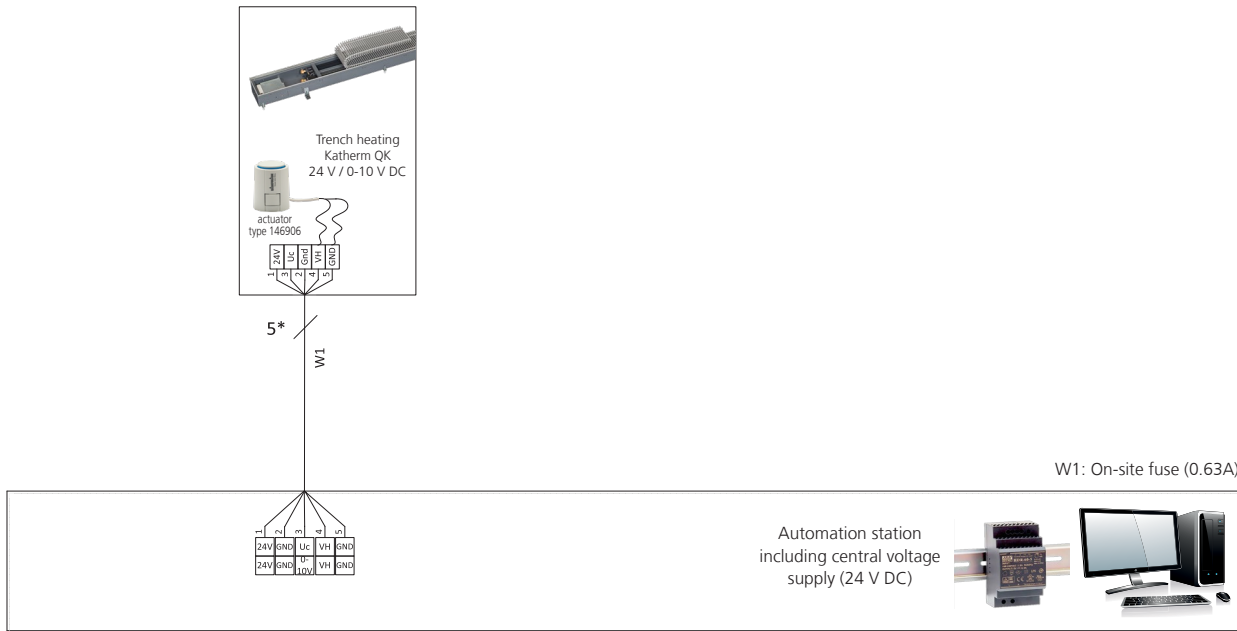

* Lay shielded cables (e.g. IY(ST)Y, 0.8 mm), separately from high-voltage cables.
W1: Voltage supply and control signal for (on-site fuse 0.63 A) and actuator.
Subject to technical modifications: Refer to the control accessory documentation in the event of deviation from the circuit diagrams!

Electrical cabling – control via clock thermostat, type 30456

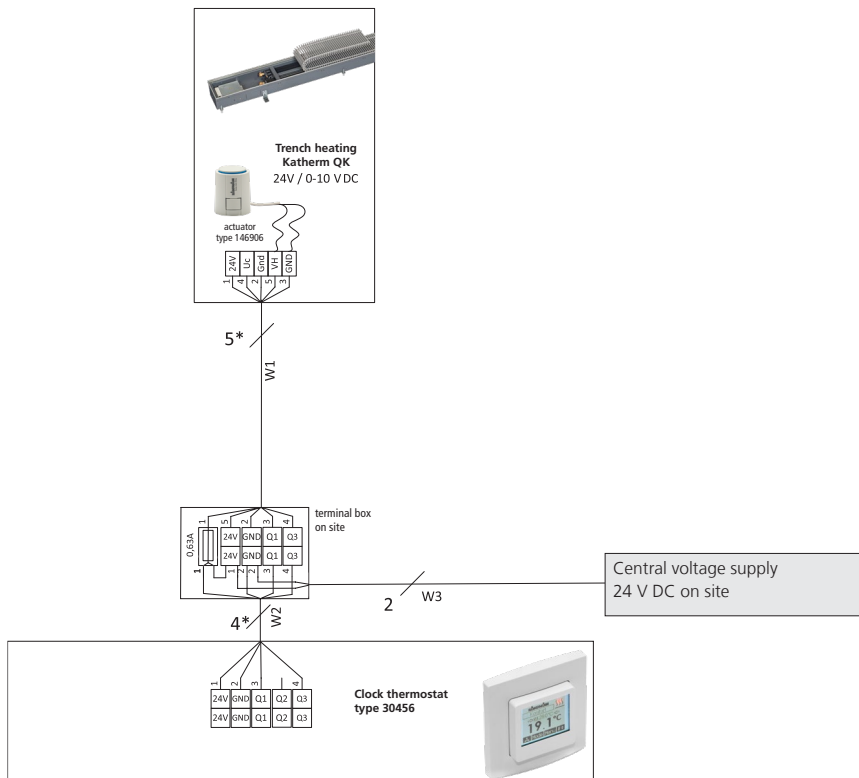

* Lay shielded cables (e.g. IY(ST)Y, 0.8 mm), separately from high-voltage cables.
W1: Voltage supply and control signal for fan (on-site fuse 0.63 A) and actuator.
W2: Voltage supply and control signal for fan and actuator.
W3: Voltage supply (fuse by others).

230 V electromechanical model

Design for on-site control or for room regulation with intuitive operation of the trench convectors.

- ▶ In the event of a motor fault, the fan automatically switches off and a fault signal is issued at a potential-free contact.
- ▶ Kampmann offers an extensive range of control accessories for all required functions.

Product features

- ▶ The Katherm QK features an integral switch power supply to connect to the 230 V AC voltage supply.

Table with rating values

Trench length [mm]	QK 190 / QK 215 Power consumption P [W] Current consumption I [mA] at fan speed									
	20%		40%		60%		80%		100%	
	P [W]	I [mA]	P [W]	I [mA]	P [W]	I [mA]	P [W]	I [mA]	P [W]	I [mA]
1000	3.6	54	4.1	58	4.5	61	5.2	68	6.3	76
1200	3.8	56	4.5	62	5.2	67	6.1	73	7.7	86
1400	4.2	58	4.8	64	6.0	72	7.4	84	9.2	97
1600	4.4	60	5.2	67	6.7	79	8.6	95	10.9	114
1800	4.5	65	5.4	74	6.8	84	8.7	95	11.5	114
2000	4.5	65	5.4	74	6.8	84	8.7	95	11.5	114
2200	6.1	68	7.0	75	7.8	84	8.8	96	12.1	114
2400	6.3	68	7.3	75	8.3	85	10.5	97	13.6	117
2600	6.5	71	7.5	76	8.8	86	11.3	102	15.0	128
2800	6.6	73	7.7	79	9.9	95	12.9	116	17.4	146
3000	6.7	73	8.0	81	10.5	97	13.8	121	19.4	159
3200	6.8	74	8.2	83	10.8	101	14.6	128	21.1	173

The power and current consumption of the actuators (1 W) is not taken into account.

Electrical cabling - BMS control

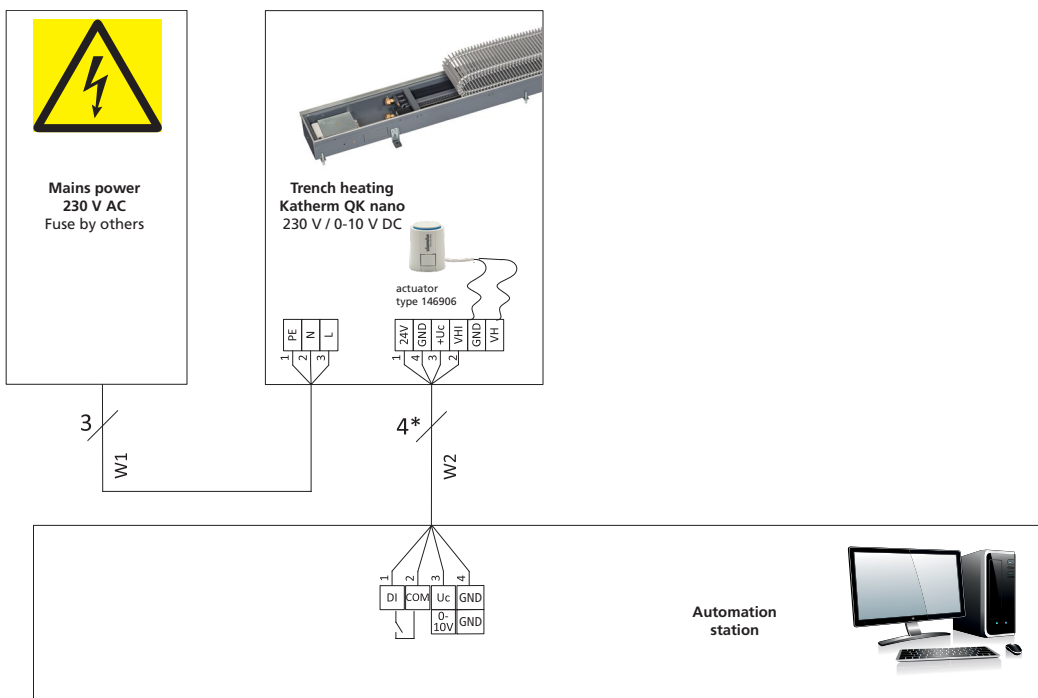

* Lay shielded cables (e.g. IY(ST)Y, 0.8 mm), separately from high-voltage cables.

W1: Power supply

W2: Control signal for fan and actuator

Subject to technical modifications: Refer to the control accessory documentation in the event of deviation from the circuit diagrams!

Electrical cabling – control via room thermostat, type 342924

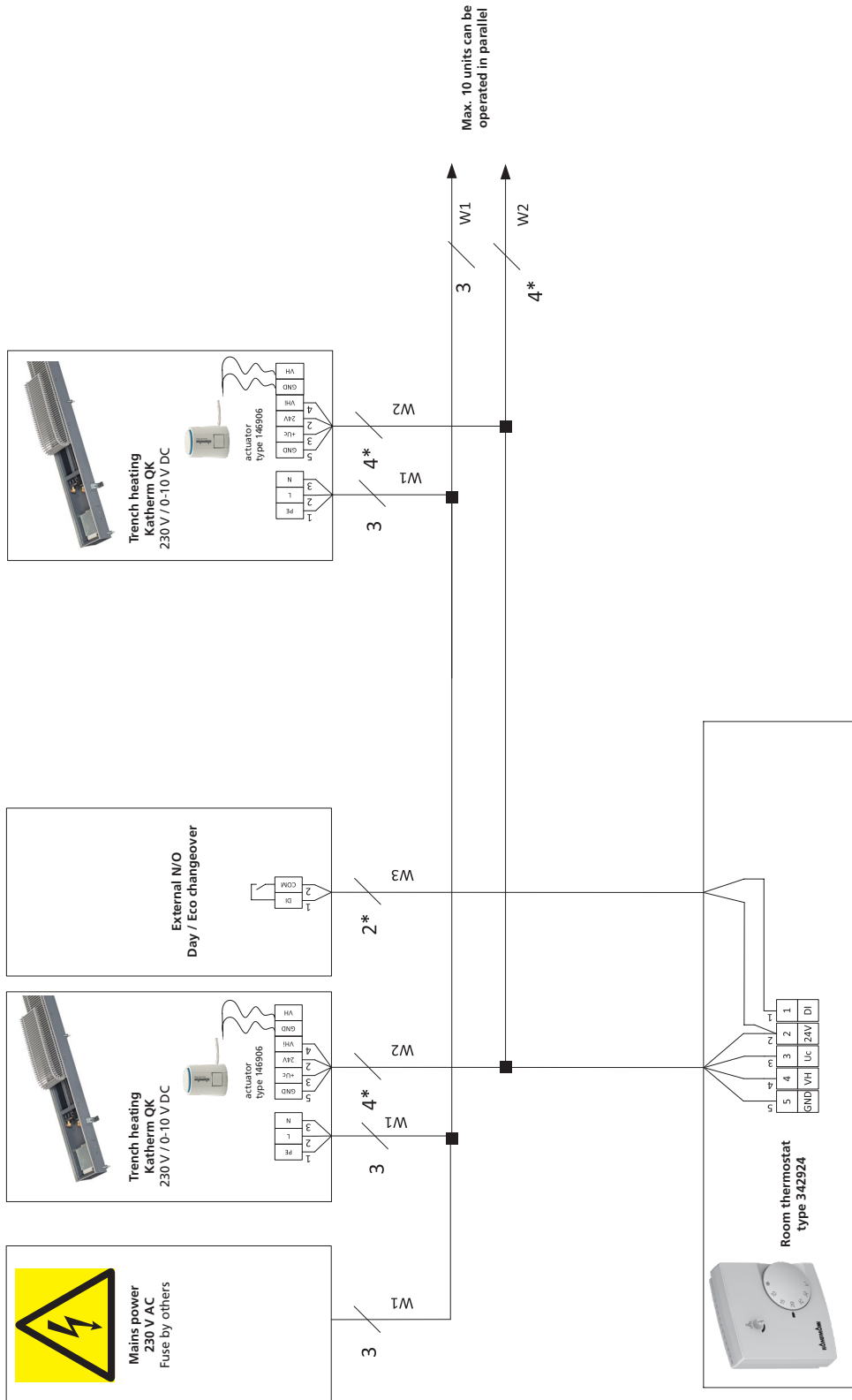

* Lay shielded cables (e.g. IY(ST)Y, 0.8 mm), separately from high-voltage cables.

W1: Power supply

W2: Control signal for fan and actuator

W3: Operating mode changeover (optional)

Subject to technical modifications: Refer to the control accessory documentation in the event of deviation from the circuit diagrams!

KaControl model

The all-inclusive solution for room automation and networking

Product features

- ▶ A high-performance parametrised microprocessor is designed to carry out all necessary functions. Each Katherm QK is therefore equipped with its own "intelligence" and can be operated in groups via Kampmann networks.

Connection to building automation systems

- ▶ Katherm QK with KaControl can be equipped with plug-in communication interfaces for controlled operation in individual rooms or for linking into higher-order control systems: BACnet, CAN bus, LON, KNX and Modbus. Direct control via an active 0-10 V signal from the on-site building management system is alternatively possible.

Motor protection

- ▶ Any faults with the motor e.g. overloading are analysed by the electronics within the EC motor. This then switches the fan off.

KaControl

The parametrisable KaControl offers a wide range of functions:

- ▶ optional: 5 fan speed settings; manually adjustable
- ▶ valve control for 2-pipe applications for thermoelectric valve actuators 24 V DC OPEN/CLOSE
- ▶ integrated timer program for programming day and week switching functions in the KaController unit
- ▶ motor monitoring with fault signal processing

KaController operating unit



The "face" of the KaControl building automation system: the KaController operating unit.

With a large display and one-touch operation, the KaController is very easy to use. With the basic principle, "as little as possible, as much as required", even untrained users can intuitively get to grips with the control options.

The basic functions for comfortable interior temperatures are set in a user-friendly way using the KaController.

Product features

- ▶ room control unit, wall-mounted, high-grade design
- ▶ available with or without function buttons on the side
- ▶ plastic housing, colour similar to RAL 9010
- ▶ communication interface to Kampmann T-LAN bus system
- ▶ large display with automatic back light
- ▶ integral room temperature sensor
- ▶ push-turn navigator dial with endless turn/lock function
- ▶ built-in weekly switching program
- ▶ password-protected parameter level

Table with rating values

Trench length [mm]	QK 190 / QK 215 Power consumption P [W] Current consumption I [mA] at fan speed									
	20%		40%		60%		80%		100%	
	P [W]	I [mA]	P [W]	I [mA]	P [W]	I [mA]	P [W]	I [mA]	P [W]	I [mA]
1000	3.6	54	4.1	58	4.5	61	5.2	68	6.3	76
1200	3.8	56	4.5	62	5.2	67	6.1	73	7.7	86
1400	4.2	58	4.8	64	6.0	72	7.4	84	9.2	97
1600	4.4	60	5.2	67	6.7	79	8.6	95	10.9	114
1800	4.5	65	5.4	74	6.8	84	8.7	95	11.5	114
2000	4.5	65	5.4	74	6.8	84	8.7	95	11.5	114
2200	6.1	68	7.0	75	7.8	84	8.8	96	12.1	114
2400	6.3	68	7.3	75	8.3	85	10.5	97	13.6	117
2600	6.5	71	7.5	76	8.8	86	11.3	102	15.0	128
2800	6.6	73	7.7	79	9.9	95	12.9	116	17.4	146
3000	6.7	73	8.0	81	10.5	97	13.8	121	19.4	159
3200	6.8	74	8.2	83	10.8	101	14.6	128	21.1	173

The power and current consumption of the actuators (1 W) is not taken into account.

Electrical cabling - 24 V Open / Close valve, external KaController

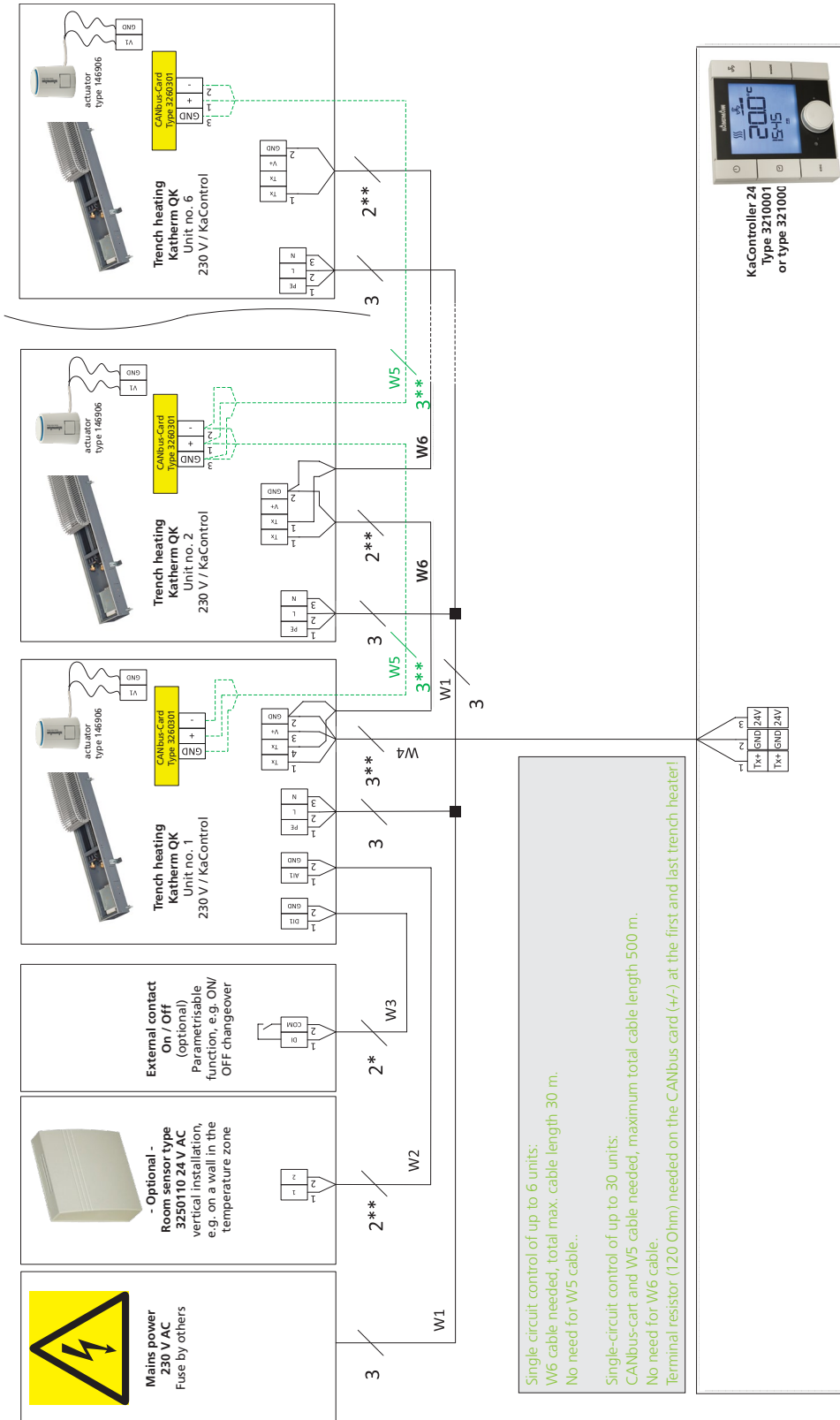

* Lay shielded cables (e.g. IY(ST)Y 0,8 mm) separately from high-voltage cables.

** Lay shielded, paired cables, e.g. UNITRONIC® BUS LD 2x2x0,22 or equivalent, separately from high-voltage cables.

W1: Power supply

W2: Analogue input AI1 (optional connection), max. cable length 10 m, from 1 mm² 30 m.

W3: Digital input DI1 (optional connection), max. cable length 30 m, from 1 mm² 100 m.

W4/W6: Bus signal (TLan), each max. total cable length 30 m.

W5: Bus signal (CANbus) only needed in a single-circuit control of up to 30 units.

Subject to technical modifications: Refer to the control accessory documentation in the event of deviation from the circuit diagrams!

KaControl electrical cabling - BMS control

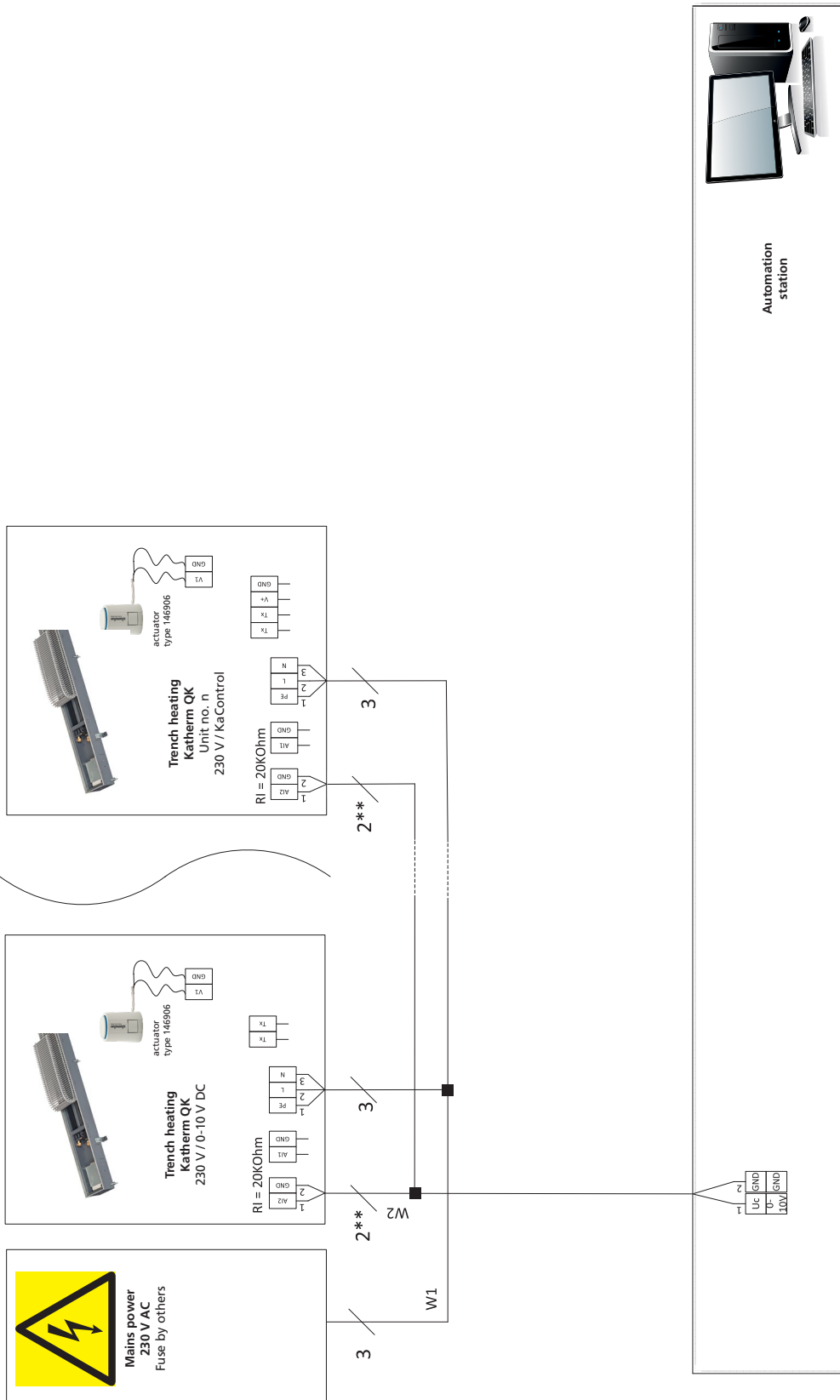

** Lay shielded, paired cables, e.g. CAT5 (AWG23) of at least the same value, separately from high-voltage cables.

W1: Power supply

W2: Control signal for fan and actuator.

Subject to technical modifications: Refer to the control accessory documentation in the event of deviation from the circuit diagrams!

05 ▶ Ordering information

Katherm QK

Design	Trench width	Control option	Grille finish	Art. no.
	[mm]			
Trench length: 1000 mm – 3200 mm Grille bar spacing 12 mm, free area approx. 70% (aluminium, brass) Bar spacing 10.5 mm, free area approx. 65% (stainless steel)				
QK 190	190	electromechanical 24 V	Roll-up grille	14241111111524
			Linear grille	14241113111524
		electromechanical 230 V	Roll-up grille	14241111111500
			Linear grille	14241113111500
		KaControl	Roll-up grille	142411111115C1
			Linear grille	142411131115C1
QK 215	215	electromechanical 24 V	Roll-up grille	14243111111524
			Linear grille	14243113111524
		electromechanical 230 V	Roll-up grille	14243111111500
			Linear grille	14243113111500
		KaControl	Roll-up grille	142431111115C1
			Linear grille	142431131115C1



Design	Trench width	Control option	Grille finish	Art. no.
	[mm]			
Trench length: 1000 mm – 3200 mm Grille bar spacing 9 mm, free area approx. 65 % (aluminium, brass)				
QK 190	190	electromechanical 24 V	Roll-up grille	14242111111524
			Linear grille	14242113111524
		electromechanical 230 V	Roll-up grille	14242111111500
			Linear grille	14242113111500
		KaControl	Roll-up grille	142421111115C1
			Linear grille	142421131115C1
QK 215	215	electromechanical 24 V	Roll-up grille	14244111111524
			Linear grille	14244113111524
		electromechanical 230 V	Roll-up grille	14244111111500
			Linear grille	14244113111500
		KaControl	Roll-up grille	142441111115C1
			Linear grille	142441131115C1



Trench convectors are supplied as standard with a natural anodised aluminium grille. This can be replaced by one of the following grilles at a surcharge. Please change the two red digits to the left of the red line in the article number to select an alternative grille.

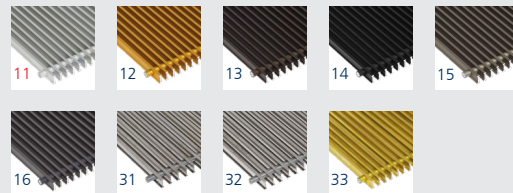

Article key for grille finish (example of art. no.)

- 14241111111500
- 0 → Aluminium, natural anodised (standard)
 - 12 → Aluminium, brass anodised
 - 13 → Aluminium, bronze anodised
 - 14 → Aluminium, black anodised
 - 15 → Aluminium, light bronze
 - 16 → Aluminium, painted DB 703
 - 31 → Stainless steel, natural
 - 32 → Stainless steel, polished
 - 33 → Brass, natural CuZn 44

The available convector lengths are in 200 mm increments (1000 mm to 3200 mm). Please change the two red digits to the right of the red line in the article number to select the required convector length.



Article key for grille finish (example of art. no.)

- 14241111111500
- 0 → Trench length 1000 mm
 - 19 → Trench length 1200 mm
 - 23 → Trench length 1400 mm
 - 27 → Trench length 1600 mm
 - 31 → Trench length 1800 mm
 - 35 → Trench length 2000 mm
 - 39 → Trench length 2200 mm
 - 43 → Trench length 2400 mm
 - 47 → Trench length 2600 mm
 - 51 → Trench length 2800 mm
 - 55 → Trench length 3000 mm
 - 59 → Trench length 3200 mm

Accessories

Figure	Article	Properties	Suitable for	Art. no.
Valves				
	Valve kit valve body, 24 V actuator and return fitting	Valve body, straight form, 1/2" connection, pre-settable, return shut-off valve, straight, 1/2" connection, 24 V thermoelectric actuator	All models	194000142110
	Valve body, straight, connection 1/2", pre-settable	As a low-noise, flow-optimised design with stainless steel spindle and double O-ring seal, to fit Katherm QK with actuator art. no. 194000146906. Max operating temperature 120 °C Maximum operating pressure 10 bar	All models	194000346909
	Adjustment key	Pre-settable	Valve bodies, art. no. 194000346909	194000346915
Return valves				
	Return shut-off valve straight, connection 1/2"	Brass, nickel-plated housing with O-ring seal, max. operating temperature 120°C, max. operating pressure 10 bar	All models	194000145952
Valve actuators				
	Thermoelectric actuator, 24 V	Power uptake approx. 1 W, Connecting cable length approx. 1000 mm, Overall height 58 mm, total width 49 mm, with valve adapter ring	All valve bodies	194000146906

more »

Figure	Article	Properties	Suitable for	Art. no.
24 V electromechanical control accessories				
	Power unit for max. 1 Katherm QK	230 V AC/24 V: for max. 1 Katherm QK 24 V model, for external installation outside the trench convector	Katherm QK, 24 V electromechanical model	196901335152
	Power unit for max. 3 Katherm QK	230 V AC/24 V: for max. 3 Katherm QK 24 V model, for external installation outside the trench convector		196901338401
	Power unit for max. 5 Katherm QK	230 V AC/24 V: for max. 5 Katherm QK 24 V model, for external installation outside the trench convector		196901338402
	Clock thermostat type 30456	Clock thermostat 24 V, heating/cooling with 2-pipe system, flush-mounted, continuously variable, with LCD operating menu and integrated timer program, heating/cooling changeover by means of external potential-free contact (low voltage)	Katherm QK, 24 V electromechanical model	196000030456
230 V electromechanical control accessories				
	Room thermostat type 342924	Continuously variable speed controller combined with a thermostat for room temperature dependent two-point control of Katherm QK units. The fan speed is set manually on the speed controller at between 0-100%. The thermostats activate the Katherm QK temperature-dependent in at the pre-set speed.	Katherm QK, 230 V electromechanical model	194000342924
KaControl accessories				
	KaController operating unit with one-touch operation	Operating unit, wall-mounted, in high-grade design, plastic housing, colour similar to RAL 9010, large LCD multifunctional display, integrated room temperature sensor, communication interface to Kampmann T-LAN bus system, automatically switching LED backlight, press/turn dial with click stop function, individually adjustable basic display, integrated day, night and week program, password-protected parameter level for C1 control option	Katherm QK, KaControl model	196003210001

[more »](#)

Figure	Article	Properties	Suitable for	Art. no.
	KaController operating unit with side function keys	For quick access to fan setting, operating modes, Eco mode, time and timer program, otherwise as art. no. 196003210001	Katherm QK, KaControl model	196003210002
	KaController operating unit with one-touch operation	Room control unit for wall mounting, high-quality design, plastic housing, colour similar to RAL 9017, otherwise as art. no. 169003210001	Katherm QK, KaControl model	196003210006
	Room temperature sensor	For wall mounting, IP30 surface-mounted, white RAL 9010, alternative to the temperature sensor in the KaController	Katherm QK, KaControl model	196003250110
	Pipe clip-on sensor	For detecting the temperature of the medium, including strap, 3 m cable, to protect the unit from frost	All models	196003250115
	Serial CANBus card	To increase the number of units in a single-circuit system to a maximum of 30 units, 1x required per Katherm QK unit	Katherm QK KaControl model	196003260301
	Serial Modbus card	For connection to BMS and automation units	Katherm QK KaControl model	196003260101
	Serial KNX card	For integration into KNX-/EIB networks	Katherm QK KaControl model	196003260701
Other accessories				
	Installation cover	Made of wood to provide protection during installation, factory-fitted Grilles are supplied separately	Katherm QK 190	194000100919
			Katherm QK 215	194000100922



kampmanngroup.com/katherm-qk
kampmanngroup.com/katherm-qk-nano
Kampmann.co.uk/katherm-qk
Kampmann.co.uk/katherm-qk-nano

Kampmann GmbH & Co. KG
Friedrich-Ebert-Str. 128 - 130
49811 Lingen (Ems)
Germany

T +49 591 7108-660
F +49 591 7108-173
E export@kampmann.de
W Kampmanngroup.com

Kampmann UK Ltd.
Dial House, Govett Avenue
Shepperton, Middlesex, TW17 8AG
Great Britain

T +44 (0)1932 228592
F +44 (0)1932 228949
E info@kampmann.co.uk
W Kampmann.co.uk

