

## Krantz Components

Conical displacement outlet  
VA-K....

**Air distribution systems**

*Krantz*

# Conical displacement outlet

## Preliminary remarks and construction design

### Preliminary remarks

In general industrial applications, to generate a stable displacement air flow, the supply air is discharged either above the floor or from low room heights – with few exceptions. The discharge height rarely exceeds 4 m.

Yet in particular cases, e.g. in aircraft painting hangars, the supply air must be discharged from a great height, some 25 m and more. Pollutants such as solvent vapours, paint aerosols, grinding residue, etc., must be displaced from the work zone down to the return air openings. Depending on outdoor air and the required room air conditions the supply air can be colder or warmer than the indoor air.

It is for such purposes that Krantz Components have developed the conical displacement outlet which is ideally suited to the requirements, even in conjunction with closed ceiling systems. This outlet is also well suited for use in sports halls such as ice skating halls where for the spectator area higher temperatures are required than in the skating area. Here it is best to combine the conical displacement outlet with, for example, the swivel jet outlet (see brochure DS 1249 E).

A permanent requirement is the generation of a stable, downward low-turbulence displacement flow. For this purpose the conical displacement outlet can be adapted to the prevailing load by adjustment of the jet direction.

The conical displacement outlet can be installed flush with the ceiling or freely suspended.

There are 2 outlet sizes: DN 630 for heights up to 18 m, nominal volume flow rate 695 l/s [2 500 m<sup>3</sup>/h], and DN 800 for heights up to 30 m, nominal volume flow rate 2 800 l/s [10 000 m<sup>3</sup>/h].

### Construction design

The upper part of the conical displacement outlet consists of the circular housing 1 with connection spigot 2<sup>1)</sup>, and the lower part is made up of a perforated sheet metal cylinder 3 with conical neck 4 to generate a low-turbulence displacement flow. In the outlet centre there is a core tube 5 with rounded inlet 6. The inlet to the core tube can be opened or closed with valve discs 7 as required.

A peripheral annular gap 8 results from the different diameters of housings 1 and 3; this gap can be covered with a surrounding seal 9.



Fig. 1: Conical displacement outlet installed in the ceiling of a 26 m high hall

The valve discs 7 and the surrounding seal 9 are linked mechanically. When the core tube 5 and the annular gap 8 are open, the valve discs are closed and vice versa. Adjustment is by means of a lift movement using an electric actuator 10.

The conical displacement outlet is made of galvanized sheet metal.

#### Key

- 1 Housing
- 2 Connection spigot<sup>1)</sup>
- 3 Perforated sheet metal cylinder
- 4 Conical neck
- 5 Core tube
- 6 Inlet
- 7 Valve disc
- 8 Peripheral annular gap
- 9 Surrounding seal
- 10 Actuator
- 11 Support ring (if required for ceiling by others)

Table 1: Technical data

Nominal $\phi$		DN 630	DN 800
$\phi D$	mm	628	798
$\phi D_1$	mm	1 060	1 625
$\phi D_2$	mm	1 000	1 500
$\phi D_3$	mm	160	250
H	mm	720	1250
H <sub>1</sub>	mm	80	100
H <sub>2</sub>	mm	300	600
$\square B \times L$	mm	600 x 700	1280 x 900
Weight	kg	approx. 96	approx. 220

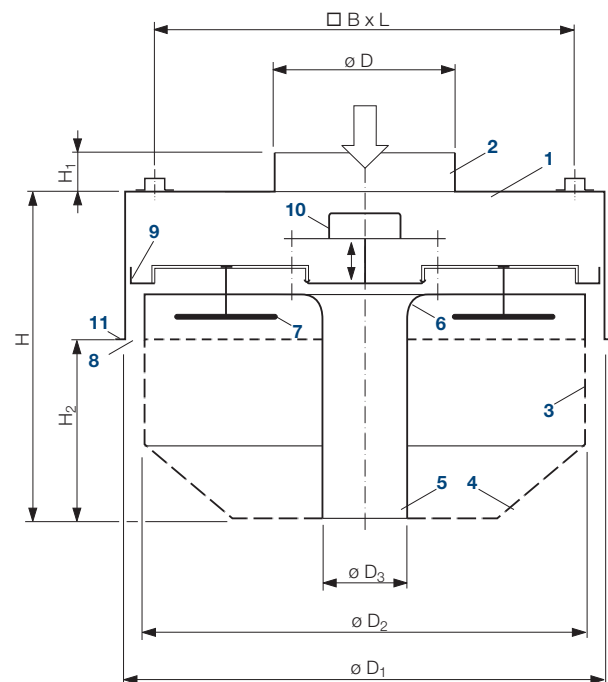


Fig. 2: Dimensions of conical displacement outlet

<sup>1)</sup> Spigot with round flange to DIN 12220 on request

# Conical displacement outlet

## Mode of operation and discharge pattern

### Mode of operation

The supply air flows through the connection spigot into the air outlet. Depending on the lift position of the valve discs linked to the surrounding seal, more or less supply air flows through the perforated sheet metal cylinder and conical neck or through the core tube and peripheral annular gap (Fig. 3).

The perforated sheet ensures low-turbulence supply air jets. The discharge direction is vertical down, at an incline, or horizontal. In cooling mode, a pronounced displacement flow is generated down to the floor.

With declining cooling load and rising heating load, more air is discharged through the core tube and the annular gap. With their strong discharge momentum, the resultant vertical support jets induce the air jets from the perforated sheet metal cylinder and conical neck. This produces a stable low-turbulence overall jet down to the occupied zone. In maximum heating mode too, the pollutants are effectively displaced downwards to the return air openings and extracted.

### Discharge pattern

The discharge pattern for different load conditions is illustrated in Fig. 3. With increasing heating load an increasing quantity of air is discharged downwards through the core tube and the peripheral annular gap. The penetration depth of the supply air can be continually adjusted by altering the lift of the valve discs and surrounding seal.

The optimum discharge pattern depends on discharge height and temperature difference between supply air and return air. The lift for any workplace height and different temperature differences can be read off Graph 1 and Graph 4.

The maximum temperature difference  $\Delta\vartheta$  between supply air and return air is  $-5\text{ K}$  (when cooling) and up to  $+8\text{ K}$  (when heating). This air outlet is also well suited for sporadic heating-up operations with temperature differences  $\Delta\vartheta$  of up to  $+10\text{ K}$  where the supply air even reaches the floor zone.

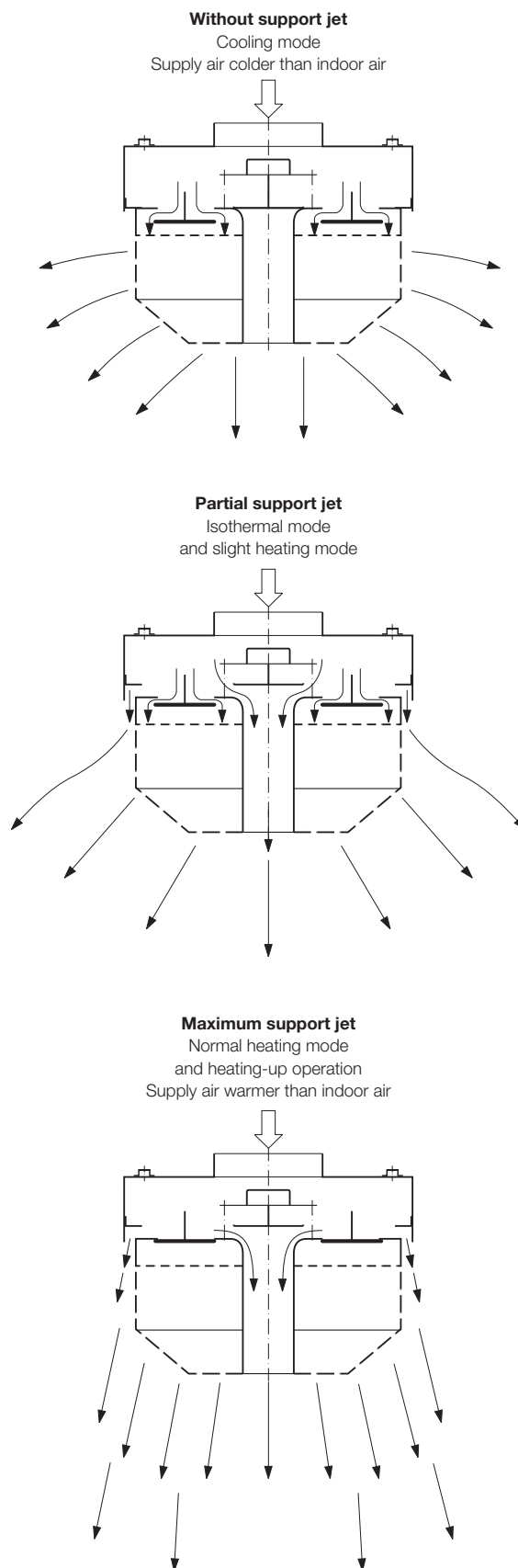


Fig. 3: Sketch of discharge pattern

# Conical displacement outlet

## Selection and layout

Conical displacement outlets generate a low-turbulence displacement flow and supply air from great heights (from 6 to 30 m). They are placed under the room/hall ceiling. The supply air penetrates deep into the room when cooling and heating, and is extracted in the floor zone.

The coverage radius of the supply air jets of an air outlet amounts to about 3 to 5 m and the recommended air outlet centre spacing is about 5 to 9 m.

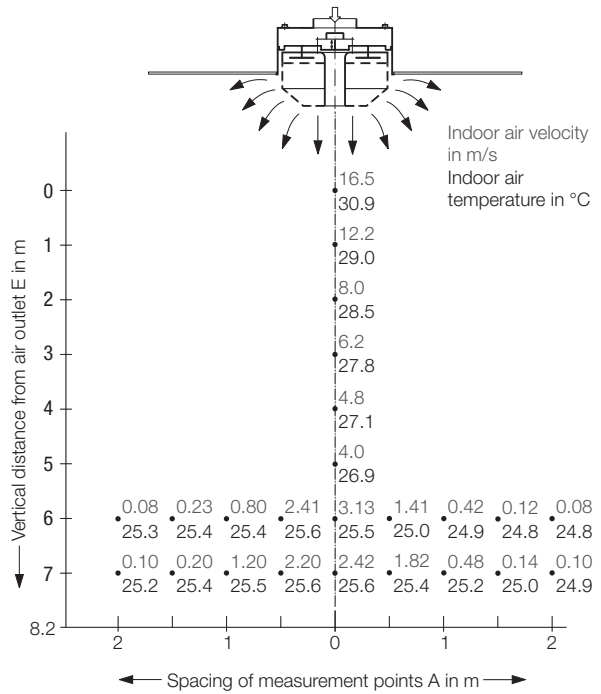
The conical displacement outlet is supplied with a built-in electric actuator to alter the jet penetration depth in response to the internal heat loads.

### Size DN 630

Size DN 630 is usually installed at a height between 6 and 18 m. The nominal air volume flow rate amounts to 695 l/s [2 500 m³/h]. Fig. 4 shows the typical jet pattern in heating mode. The supply air flows only through the core tube and the annular gap. Fig. 5 shows the indoor air velocities and temperatures below the air outlet.



**Fig. 4:** Heating mode with air outlet volume flow rate of 695 l/s [2 500 m³/h] and  $\Delta\vartheta_H = +8$  K from 8.2 m height



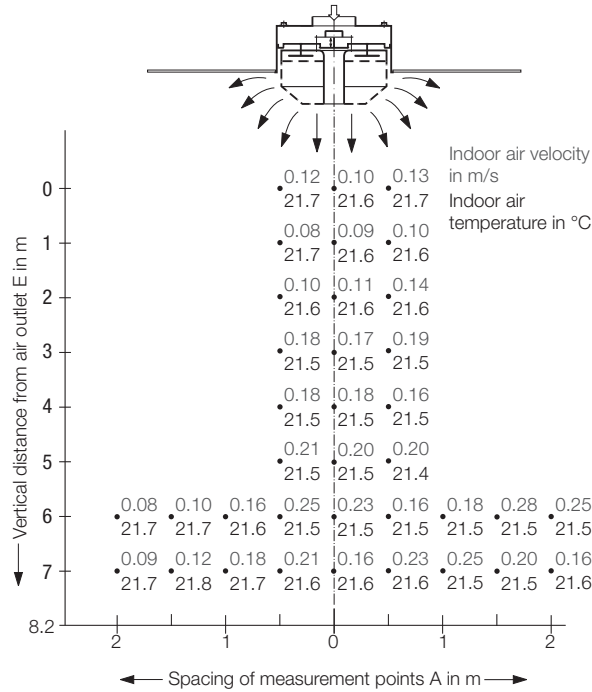
**Fig. 5:** Indoor air velocities and temperatures with air outlet volume flow rate of 695 l/s [2 500 m³/h] and  $\Delta\vartheta_H = +8$  K (heating mode)

In cooling mode the supply air is discharged only through the perforated sheet metal cylinder of the air outlet (Fig. 6). This creates a low-turbulence displacement flow inclined downwards, with low air velocities (Fig. 7).



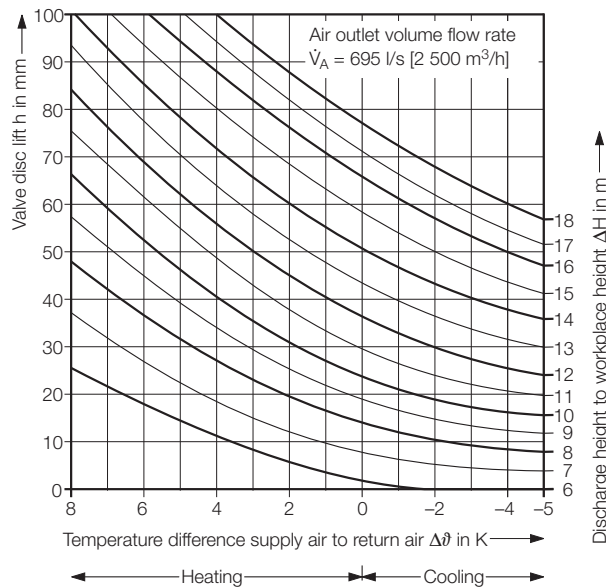
**Fig. 6:** Cooling mode with air outlet volume flow rate of 695 l/s [2 500 m³/h] and  $\Delta\vartheta_K = -5$  K from 8.2 m height

# Conical displacement outlet



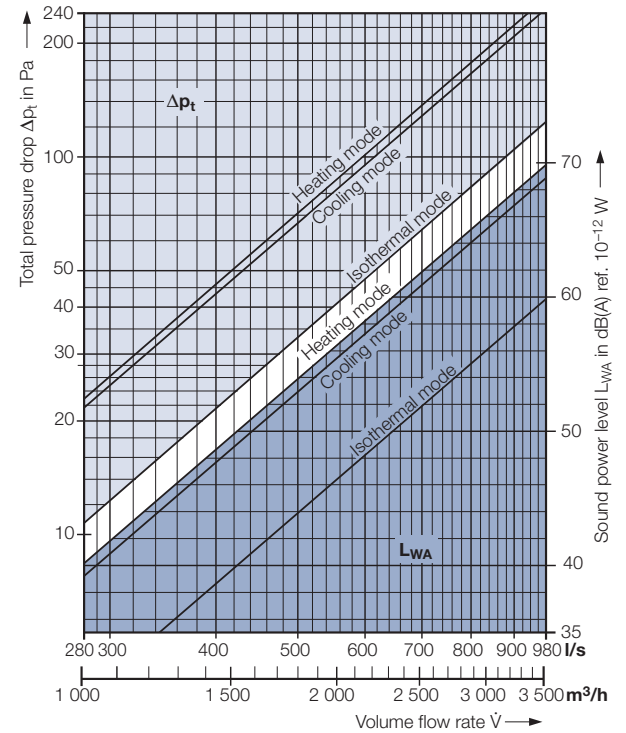
**Fig. 7: Indoor air velocities and temperatures with air outlet volume flow rate of 695 l/s [2 500 m³/h] and  $\Delta\vartheta_K = -5$  K (cooling mode)**

Graph 1 helps set the lift of the valve discs. The maximum lift of 100 mm corresponds to the full opening of core tube and annular gap for maximum heating mode.



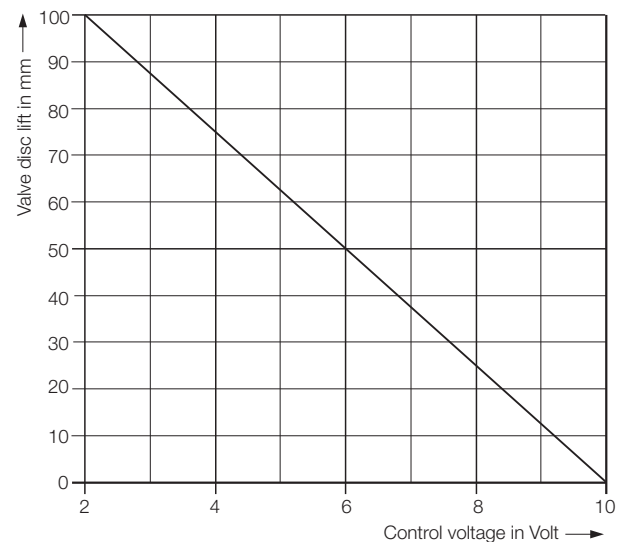
**Graph 1: Valve disc lift in response to temperature difference between supply and return air at different distances between discharge height and workplace height**

Sound power level and pressure drop are shown in Graph 2. The values for the heating mode apply to a valve disc lift of 90 mm.



**Graph 2: Sound power level and pressure drop**

The discharge pattern is adjusted via an electric actuator. Graph 3 shows the related control curve. A 100% lift (100 mm) implies that core tube and annular gap are fully open. This ensures the maximum penetration depth of the supply air in heating mode. If the valve disc lift is 0%, the supply air is discharged only through the perforated sheet metal cylinder and conical neck of the air outlet (cooling mode).



**Graph 3: Valve disc lift depending on control voltage**

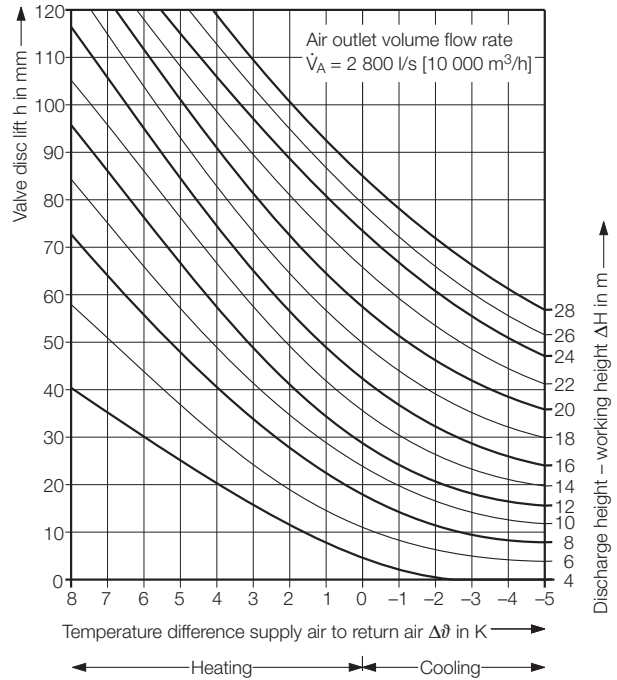
# Conical displacement outlet

## Size DN 800

Size DN 800 is usually installed at a height between 8 and 28 m. The nominal air volume flow rate amounts to 2 800 l/s [10 000 m<sup>3</sup>/h]. The jet pattern is exactly the same as with size DN 630 (see Fig. 4). The supply air flows only through the core tube and the annular gap. The maximum valve disc lift is 120 mm. Fig. 8 shows the air outlet installed in an aircraft painting hangar at 26 m height.

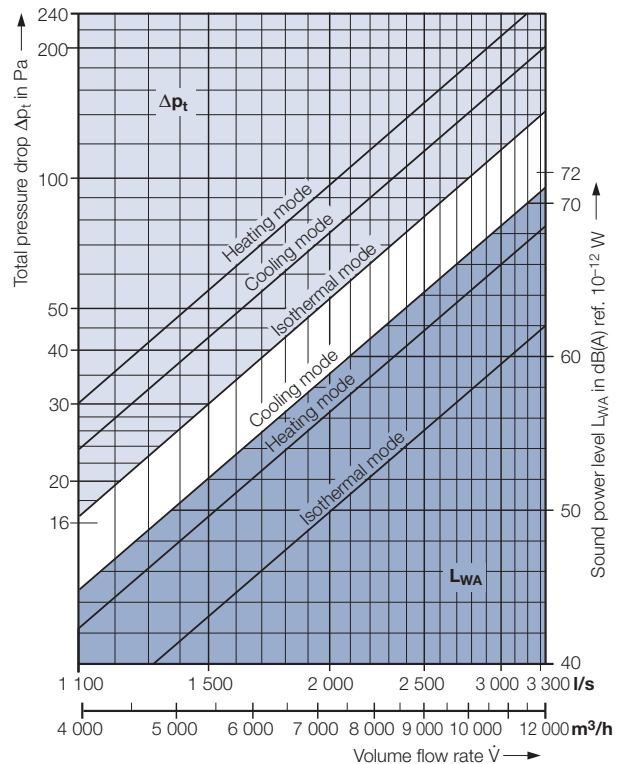


**Fig. 8:** Penetration depth of supply air jets made visible by smoke tracer



**Graph 4:** Valve disc lift in response to temperature difference between supply and return air at different distances between discharge height and workplace height

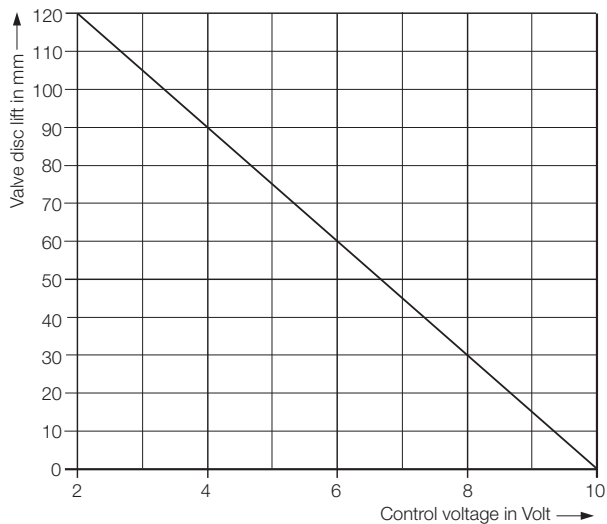
Sound power level and pressure drop are shown in Graph 5. The values for the heating mode apply to a valve disc lift of 105 mm.



**Graph 5:** Sound power level and pressure drop

## Conical displacement outlet

The discharge pattern is adjusted via an electric actuator. Graph 6 shows the related control curve. A 100% lift (120 mm) implies that core tube and annular gap are fully open. This ensures the maximum penetration depth of the supply air in heating mode. If the valve disc lift is 0%, the supply air is discharged only through the perforated sheet metal cylinder and conical neck of the air outlet (cooling mode).



Graph 6: Valve disc lift depending on control voltage

### Features

- Low-turbulence displacement flow, especially suited for aircraft painting hangars
- Discharge height 6 to 30 m
- Air discharge direction adjustable to internal loads
- Volume flow rate range from 280 to 2 800 l/s [1 000 to 10 000 m³/h]
- Low pressure drop
- Temperature difference between supply air and return air up to -5 K in cooling mode and +8 K in heating mode
- Smooth operation in heating-up operation up to  $\Delta t = +10$  K
- 2 sizes: DN 630 and DN 800
- Built-in electric actuator for adjustment of jet penetration depth

### Type code

VA - K - DN - - - -

Displacement outlet  
Design  
Size  
Adjustment  
Mounting  
Surface finish

#### Design

K = Conical displacement outlet

#### Size

630 = DN 630  
800 = DN 800

#### Adjustment

E41 = „Belimo actuator, 0 – 10 V modulation“, stroke drive type SH24A-MF200

#### Mounting

D = flush with ceiling  
F = freely suspended

#### Surface finish

9010 = face painted to RAL 9010, semi-matt

### Tender text

..... Stück

Conical displacement outlet for air supply from great heights with minimum mixing of the supply air with the indoor air for optimum displacement of dust particles and pollutants from the occupied zone, for installation flush with ceiling oder freely suspended,

consisting of:

outlet housing and perforated sheet metal cylinder with conical neck generating a low-turbulence displacement flow as well as core tube and peripheral annular gap to form support jets for adjustment of jet penetration depth, valve discs and surrounding seal for regulation of jet penetration depth, operated by electric actuator, connection spigot for duct connection.

Material:

Outlet housing with connection spigot, perforated sheet metal cylinder with conical neck, and valve discs made of galvanized sheet metal; visible parts painted to RAL 9010, pure white, or to another RAL colour.

Make:

Krantz Components

Type:

VA - K - DN - - - -

Subject to technical alterations.

**Krantz GmbH**

Uersfeld 24, 52072 Aachen, Germany

Phone: +49 241 441-1

Fax: +49 241 441-555

info@krantz.de | www.krantz.de

The logo for Krantz GmbH, featuring the word "Krantz" in a stylized, blue, cursive script font.